

# EURO<sup>2</sup>

Industry use-cases  
EuroCC-1 & -2 portfolio



EuroCC 2 and EuroCC4SEE have received funding from the European High-Performance Computing Joint Undertaking (JU) under grant agreement No 101101903 and No 101191697. The JU receives support from the European Union's Digital Europe Programme and Germany, Bulgaria, Austria, Croatia, Cyprus, Czech Republic, Denmark, Estonia, Finland, Greece, Hungary, Ireland, Italy, Lithuania, Latvia, Poland, Portugal, Romania, Slovenia, Spain, Sweden, France, Netherlands, Belgium, Luxembourg, Slovakia, Norway, Türkiye, Republic of North Macedonia, Iceland, Montenegro, Serbia, Bosnia and Herzegovina.

This material was created within the CASTIEL 2 project. This project has received funding from the European High-Performance Computing Joint Undertaking (JU) under grant agreement No 101102047. The JU receives support from the European Union's Digital Europe Programme and Germany, Italy, Spain, France, Belgium, Austria, Estonia.



# Content

NCC Name	Number of use cases reported
Austria	6
Belgium	5
Bulgaria	2
Croatia	3
Cyprus	5
Czechia	13
Estonia	4
Finland	14
France	19
Hungary	4
Latvia	4
Portugal	4
Slovakia	6
Spain	2
Sweden	3
Türkiye	6
<b>TOTAL</b>	<b>100</b>

Austria



## Time Series in the Energy Sector

### Company

HAKOM is the technology leader for time series management in the energy industry. Its PowerTSM<sup>®</sup> Technology enables and accelerates innovation.

### Challenges & Solution

The energy sector generates more data than ever before - most of it is time series data. In order to add more advanced big data analytics capabilities, the company tested its technology on a supercomputer. EuroCC Austria referred HAKOM to the experts of the Little Big Data (LBD) cluster, an HPC system at TU Wien. The successful integration of time series management (TSM) software on a highly parallel cluster enables HAKOM now to further develop the tools for analysis of very large data sets directly through its TSM system.

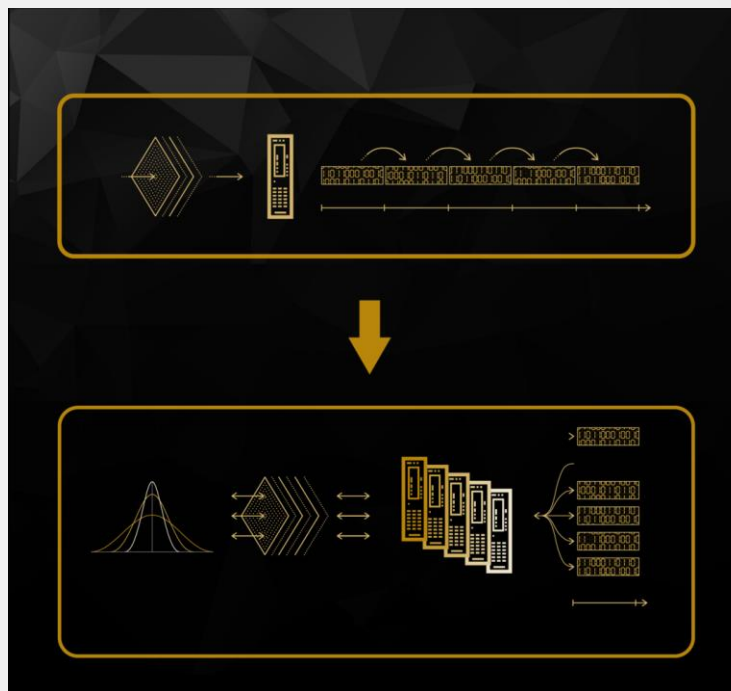

### Benefits

- more advanced big data analytics capabilities available
- enables development of tools for analysis of very large data sets directly through its TSM system

*“With the guidance of the EuroCC team we decided to export our time series data to parquet files ... With all the data residing in the distributed network file system reading subsets of data – roughly 10 GB – into a Spark distributed data frame became both doable and reasonably fast.”*

**Gregor Beyerle, Data Scientist @HAKOM**

### Full story:



➤ whole story

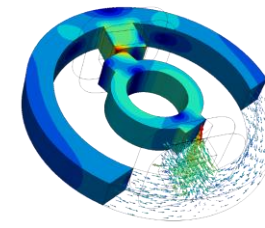
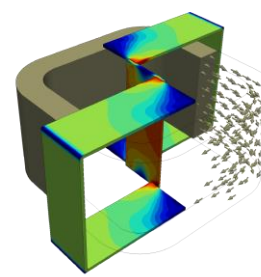

## Electromagnetic Simulations

### Company

TAILSIT, a company from Graz, Austria produces custom-fit simulation software tools for computational electromagnetics and structural analysis.

### Challenges & Solution

TAILSIT's distinctive software library employs a coupled Finite/Boundary Element Method (FEM/BEM) for electromagnetic analysis. BEM, with quadratic complexity, becomes nearly linear through Fast Multipole Method (FMM) integration. Challenges arose in limited desktop capacity. With support from the Vienna Scientific Cluster (VSC) at TU Wien the software was adapted for HPC machines, yielding significant runtime enhancements and the ability to handle problems with up to  $50 \cdot 10^9$  degrees of freedom, a major leap from its previous capacity of  $10^6$ .

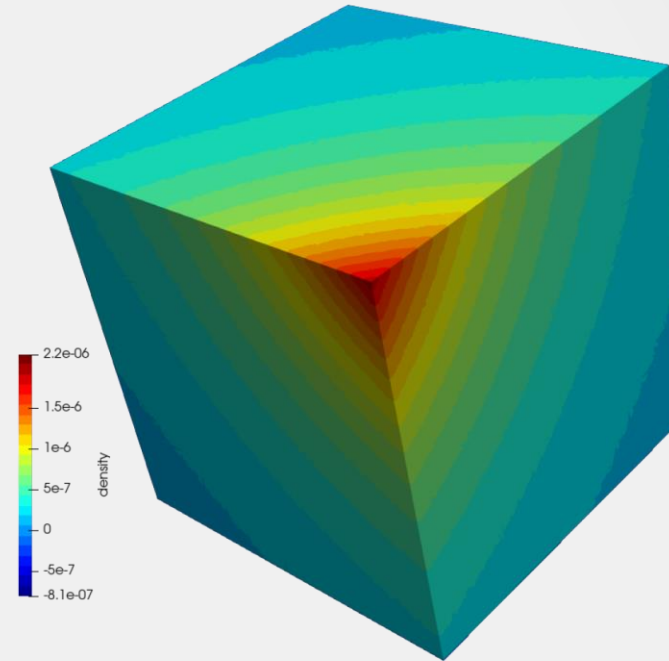

Unit cube and its calculated potential caused by a given fundamental solution

### Benefits

- significant run-time improvements
- good overall scaling for up to a few thousand CPUs
- achievement of significant upscaling of degrees of freedom

*"Based on the results and the knowledge acquired from this project, we were able to further develop our method such that the first industrial applications have been simulated. In order to harden the algorithms and thus to achieve a sustainable implementation, we will again seek cooperation with the VSC team."*

**Dr. Jürgen Zechner, CEO @TailSiT**

### Full story:



➤ publication

## Maritime transport optimization

### AlongRoute

AI based marine forecasts for weather routing solutions to achieve greener, safer and more cost-efficient shipping routes.

### Challenges & Solution

Inaccurate marine weather forecasts lead to inefficient routes, higher emissions and safety risks. Maritime transport emits nearly 3% of global CO<sub>2</sub>, projected to rise in the next decades. The ocean physics is so complex that existing numerical forecast models cannot accurately predict its behaviour. Solution is an AI model constructed of graph convolutional neural networks that forecast waves, currents and the surface wind. By using this forecast data as an input and with no other changes, existing weather ship routing systems can perform up to 1,3 times better than today. Expected cargo ship emission reduction is more than 50 million tons per year.

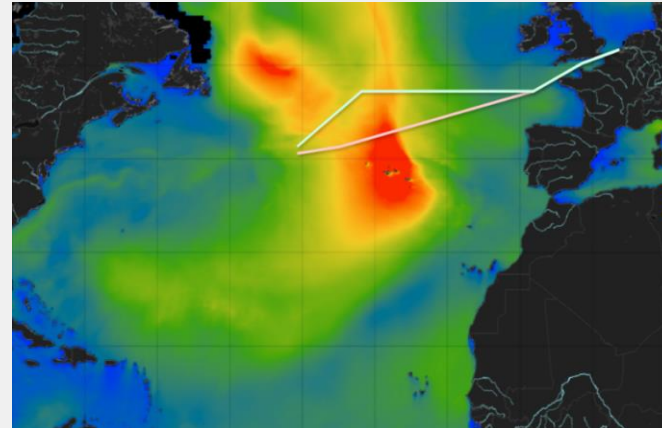

AlongRoute has developed an AI model on the VSC-5 supercomputer that can predict significant wave height with an average mean absolute error (MAE) of 0.34 m compared to reanalysis data. © AlongRoute

### Benefits

- Early detection of adverse weather conditions.
- Ensuring safety of ships and crews.
- Optimised routes = lower fuel use and CO<sub>2</sub> emissions.

*“These results are transformative for our company – both technologically and commercially. Thanks to our collaboration with EuroCC Austria, we’ve developed a highly accurate and efficient AI-based maritime weather forecasting model for the Mediterranean.”* **Vasilis Alexandridis, CTO @AlongRoute**

**Full story:**



## Cell simulation

### Myllia

Founded in 2018 in Vienna, uses single-cell RNA sequencing, CRISPR, and AI to predict cell responses, accelerating drug discovery and deepening understanding of complex diseases.

### Challenges & Solution

A key challenge in using AI for biological research is that most public datasets come from unmodified cells, making it difficult for models to predict responses to genetic changes or drug treatments. Myllia overcomes this by leveraging its unique dataset of CRISPR-modified cells, enabling AI training on directly relevant material. Another challenge is the vast computing power required to train such models but with support from EuroCC Austria, Myllia gained access to supercomputer like Leonardo, allowing them to train multiple models in parallel, refine the best ones quickly, and achieve prediction accuracy that outperforms existing tools.

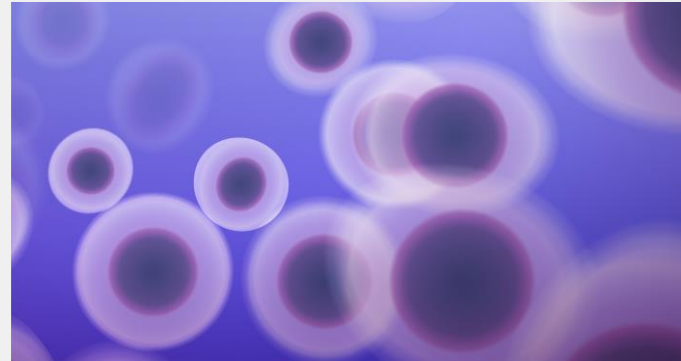

*Myllia trains an AI model that predicts how individual cells change under various influences. Unlike other models, Myllia's is based on cells that have already undergone changes, thereby delivering significantly more accurate results. ©EuroCC Austria.*

### Benefits

Unique single-cell CRISPR datasets enable more accurate prediction of cellular responses to genetic perturbations.

Access to EuroCC Austria's HPC resources speeds up model training and evaluation.

Rapid testing of model architectures and hyperparameters identifies the most promising development paths.

*"EuroCC Austria gave us access to powerful HPC infrastructure. The team was always highly committed and supportive. Thanks to their help, we were able to start our computations almost immediately."* **Adam Krejci,**

**Head of Bioinformatics @Myllia Biotechnology**

Full story:





## Tackling Nuclear Industry Challenges with AI

### Caelus

Italian start-up that develops AI tools to automate administrative and regulatory processes in the nuclear industry, enabling experts to focus on their core technical work.

### Challenges & Solution

The nuclear industry demands absolute precision, transparency, and compliance, yet standard AI models often fall short in these areas. CAELUS tackles this by developing a secure multi-agent system of fine-tuned small language models, each trained on specific regulatory and technical data, and supported by a dedicated verification, validation, and quality assurance (VV&Q) pipeline. Its modular design adapts to the different needs of each project phase, from planning to operation, ensuring reliability, flexibility, and full compliance throughout the entire life cycle of a nuclear power plant.

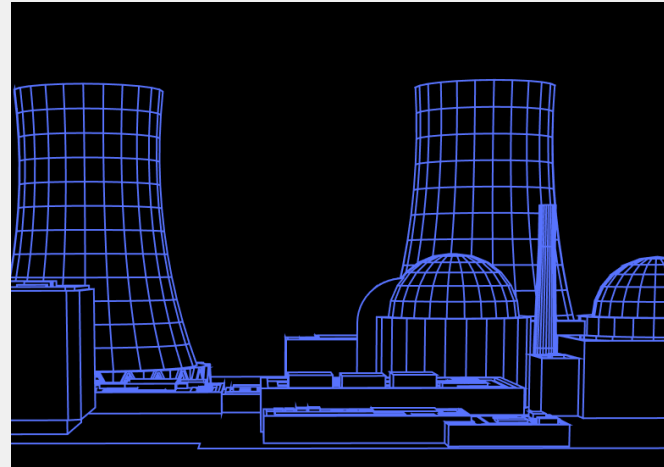

*CAELUS' AI tool independently ensures that regulatory deadlines are met and automates repetitive tasks. ©EuroCC Austria*

### Benefits

Reduces time spent on regulatory paperwork, allowing experts to focus on engineering and technical tasks.

Cuts project costs and delays through automation and optimised workflows.

Increases safety and compliance by ensuring accurate, traceable, and verified AI outputs.

*“The collaboration with EuroCC Austria was an outstanding experience. Working with such skilled and dedicated experts is invaluable for a young start-up like ours. The EuroCC team’s support inspired us to push beyond our limits and reach new milestones.”* **Lorenzo Tomassetti, Team leader @Caelus**

***Full story:***



## AI generated music

### Beatshaper

An AI copilot for music producers that generates beats, melodies, basslines, and sound settings, streamlining both songwriting and sound design.

### Challenges & Solution

A major challenge was the absence of existing datasets for their unique symbolic music approach, which required the team to create all training data from scratch. They also had to prevent overfitting so the AI could produce original yet structured music that still sounded enjoyable. To refine the model, Beat Shaper trained over 500 versions simultaneously on the Vienna Scientific Cluster supercomputer, accelerating training times by a factor of 50 and enabling large-scale experimentation. This combination of custom data, careful model tuning, and high performance computing led to an copilot capable of generating both creative and production ready content.

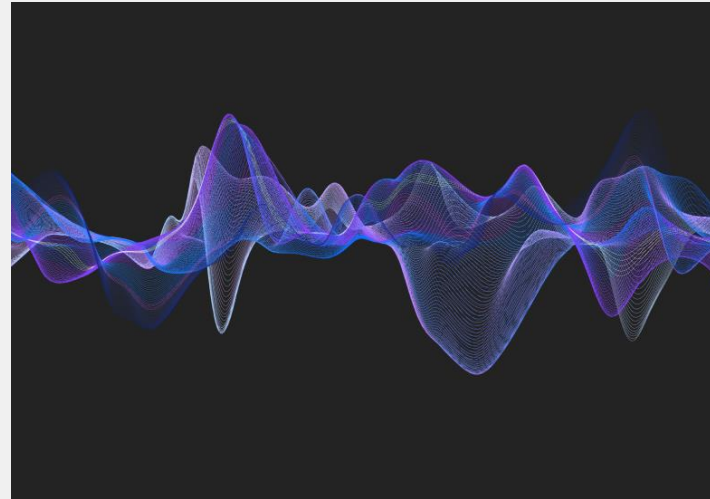

*Beat Shaper supports beginners as well as professional and semi-professional artists in producing high-quality electronic music. © EuroCC Austria*

### Benefits

Accelerated model development through 50× faster training times.

Produced a generative AI that outperforms existing tools.

Supports both beginners and professional music producers.

*“I think it's great that the EuroCC programme exists. We are competing with much larger and better-funded companies, most of which are based in the United States. Since there is hardly any significant private venture capital for early-stage start-ups in Europe, programmes like this are crucial in helping European companies remain globally competitive.”* **Taylor Peer, CEO @Beatshaper**

**Full story:**



Belgium



## Understanding physics at the microscale in filter media

### Company

Atlas Copco is specialized in the design, development and manufacturing of industrial compressors and expanders, vacuum solutions and air and gas treatment equipment.

### Challenges & Solution

The flow geometry and physics at the microscale in filter media are complex and require state-of-the-art computational fluid dynamics techniques to resolve. The required computational resources are extensive and need world-class high-performance computing.

Simulations were first performed to build the necessary experience in efficiently running large-scale calculations and exploring the computational limits. Using VSC infrastructure gave Atlas Copco access to new simulation techniques to investigate the microscale behavior of oil aerosol filter media.



Virtual filter medium microstructure

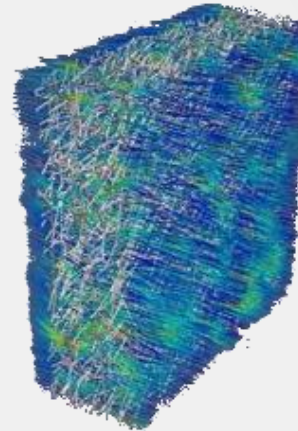

Streamlines flow through a filter medium coloured by velocity magnitude

### Benefits

- ✓ Accelerate the development of new and better designs
- ✓ Simulation of more physics and larger problems that were infeasible before
- ✚ **Cleaner air delivered at a lower energy cost to our customers**

*“Atlas Copco wanted to have a better understanding of microscale air and oil flow behaviour in oil aerosol filter media. If we better understand the physics at this scale, we can design filters with higher filtration efficiency at a lower pressure drop. This, in the end, results in cleaner air delivered at a lower energy cost to our customers”* **Tom Saenen, Technology developer @Atlas Copco**

### Full story:





## Matchmaking, mapping industry challenges to research

### Company

PUXANO is a biotech company offering structure-based protein research services to pharma and biotech companies. The company differentiates from others by developing its own technologies to accelerate the process of obtaining protein structures.

### Challenges & Solution

The procondor platform helps to optimize the protein sequence in a semi-automated manner. Puxano initially used the platform internally but wanted to automate it further and make it available for others to use.

To meet this computational demand, Puxano has employed the HPC services of VSC. Furthermore, VSC introduced Puxano to the Data Science Institute of UHasselt (DSI). DSI helped Puxano design a suitable database structure. The developed database is being incorporated into the Puxano analysis pipelines and serves as the core source of information for the Puxano (web-based) service platform.



### Benefits

- ✓ VSC as match-maker between Puxano and DSI
- ✓ DSI gave new insights to design a suitable database structure
- ✚ **The developed database serves as the core source of information for the Puxano (web-based) service platform.**

*“Our key objective was to rethink our script for protein construct design into a software platform. The idea was to find out which type of database structure served best to integrate protein information in different formats, have efficient data storage, easily updatable and searchable. Our collaboration with academia was very valuable for the success of the project”* **Wouter Van Putte, Director & co-Founder @Puxano**

### Full story:





## The Role of HPC in Ensuring Nuclear Reactor Safety

### Company

Founded in Belgium 150 years ago, Tractebel is today one of the world's leading engineering companies for energy, water and infrastructure projects.

### Challenges & Solution

In 2012, the federal agency of nuclear control of Belgium reported defects in the vessels of the nuclear reactor Doel 3 and Tihange 2. Among a lot of analyses, numerical simulation has been chosen to assess the risk level.

These simulations were highly computationally demanding. A single computation required a high quantity of memory (up to 128Gb for the first computations – feasibility proved up to 768Gb). Due to the high number of configurations to compute (some hundreds), combined with the memory needs, the use of HPC infrastructure was a requirement.



### Benefits

- ✓ HPC helped in the assessment of structural integrity
- ✓ Safe restart of the reactors (combined with inspections)
- ✎ **Tractebel acquired unique expertise and now conducts its own analyses on various parts of nuclear power plants internally but also for its partners.**

*“Multiple crack configurations required much caution to perform the computation within the available hardware resources while satisfying high-quality standards in the results. Cenaero developed methodologies to face the challenges (number of configurations, memory and restitution time limitations, post-processing).”* **Valéry Lacroix, Technical manager of seism & structural integrity group @Tractebel**

### Full story:



## Leveraging expertise

### Company

Founded in 2018, Mpacts is a SME dedicated to the development of Mpacts simulation software. It is designed to simulate the behaviour of granular materials, assemblies of large numbers of particles in industrial processes.

### Challenges & Solution

While granular dynamics is conceptually very similar to molecular dynamics, it is also much more complex since particles have shape and complex interactions, which complicates contact detection. Develop computationally efficient simulation software for granular processes is critical.

The Flemish Supercomputing Center (VSC) recommended sorting the particles so that particles close in (simulated) space are also close together in computer memory. VSC also built a tool that automates the compilation of Python modules from C++/C/Fortran. These programming techniques made the software more efficient and, thus, faster.

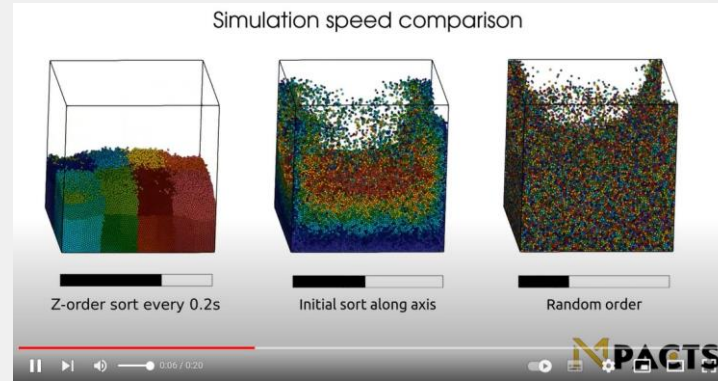

### Benefits

- ✓ Sorting the particles in memory translates into faster computation times by factor 2 with existing hardware.
  - ✓ Performance increases by a factor of five with GPUs
- 🔑 This improvement has a high impact on the responsiveness in solving engineering problems.**

*"The ability to work with the highly skilled experts in the field of HPC at VSC was a very interesting and rewarding experience. I would recommend anyone involved in supercomputing to contact the VSC and benefit from their available expertise to improve your calculations."* **Simon Vanmaercke, Co-Founder**

@Mpacts

### Full story:



## Achieving Optimal Compressor Design with AI Techniques Thanks to HPC

- **Company**

Cenaero is a private research centre located in Charleroi. With a background in digital simulation for the aeronautical sector, Cenaero aims to develop customized solutions not available on the market, and to support companies in niches in which they do not wish to invest individually. This work was done in collaboration with Safran Aero Boosters, a world-class aeronautic company.

- **Challenges & Solution**

Multi-stage compressor are the heart of the engine's compression system, operating under extreme conditions and involving hundreds of interdependent geometrical parameters — each capable of influencing efficiency, stability, and manufacturability. The challenge is exploring thousands of possibilities to discover the best. That requires Computational Fluid Dynamics (CFD) simulations. Running the required thousands of simulations would take months, even years, on conventional computers. The scale of the task meant HPC was the only viable route. Cenaero explored an AI-driven approach to simplify the design problem: dimensionality reduction. Starting from a dataset of CFD results, the team applied UMAP (Uniform Manifold Approximation and Projection) to project the high-dimensional parameter space into a more tractable representation and then used DBSCAN to cluster geometrical parameters that show similar influence on simulation outputs. Parameters that behave similarly can be grouped together, That reduces the search space while preserving the essential physics that determines compressor performance.

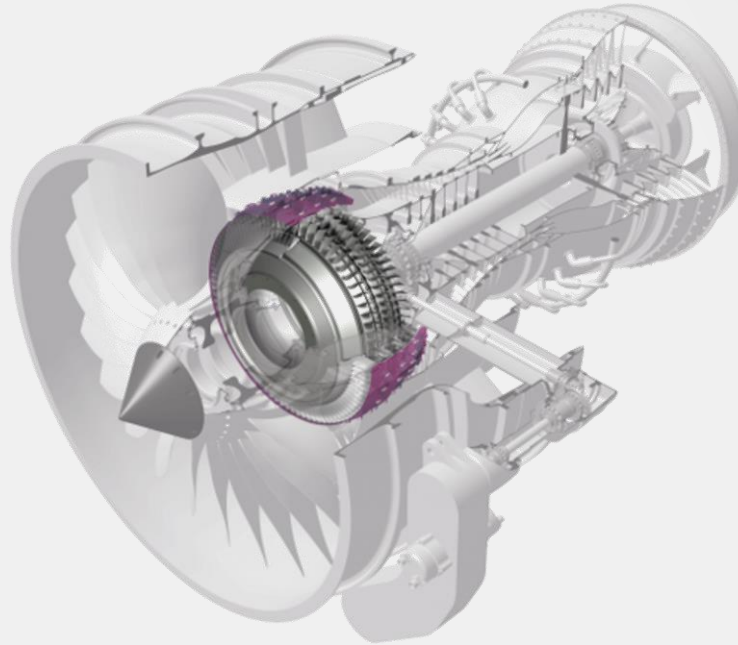

### Benefits

- ✓ Clustering parameters can shrink the search space without losing accuracy. This makes optimisation feasible at a scale that was previously out of reach.
- ✓ HPC allows to think differently, and attempt designs we might never have considered if computation were a bottleneck.
- ✦ **For the aeronautical sector, such tools will be central to designing the next generation of greener engines.**

*“Exploring such a vast design space without computational help would be like trying to map the ocean with a rowboat. The synergy between AI, HPC and engineering design is still in its early days, but its potential is enormous and we’re just beginning to tap into it.”*

**” Dr Rajan Filomeno Coelho, Senior Research Engineer at Cenaero**

**Full story :**



Bulgaria



## Supercomputer application in biomedical engineering

### Company

AMET Ltd. is a company dedicated to development, modern manufacturing and distribution of electronic medical equipment and modules. It is a reliable and desired partner in Bulgarian and foreign market.

### Challenges & Solution

The processes are substantially three-dimensional and time-dependent. The developed software tools for supercomputer simulation of coupled physical processes of radiofrequency electro surgery manipulations are beyond the scope of available commercial packages. Measurable indicators are applied to assess the reliability of the obtained results, thus providing proven criteria for minimizing subjective inaccuracies. The impact of using large-scale HPC models reached more than two times improved precision of evaluating the volume of effectively ablated tissue.

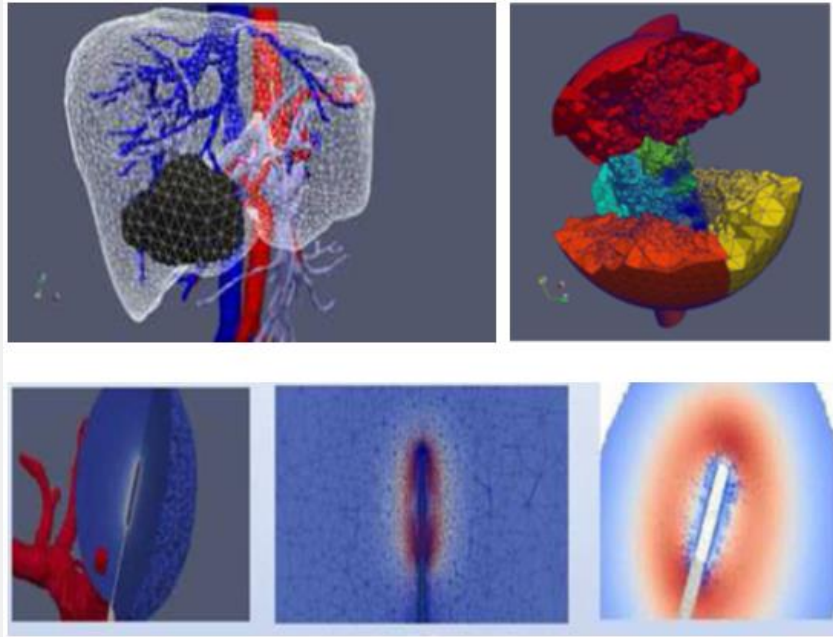

### Benefits

- ✓ Fully realistic computer simulation of strongly coupled processes of radiofrequency electrosurgical technologies.
- ✓ Time/cost saving of parameter optimization of high tech low-invasive procedures.
- ✓ Assessment and optimization of hard to measure complex processes.

*“The use of state-of-the-art modeling, simulation and high performance technologies is very important to our company. The business impact from our collaboration with ICT-BAS includes improving the technology characteristics of existing products and development of new products.”*

**Janet Popova, Managing Director @Amet Ltd.**

### Full story:





## Improving the furniture precision

### Company

PLYGear is specialized in the design, computer modelling and manufacturing of furniture born in timely recorded digital dreams supported by the plywood unique properties.

### Challenges & Solution

The models designed and implemented in virtual environment are complex and require state-of-the-art computational techniques to resolve. The required computational resources are extensive and need high-performance computing as all Plygear items need the precision of the modern processing methods.

Simulations were performed to acquire knowledge in running effectively new design methods. The impact of using large-scale HPC models improved both the precision and the production rate.



### Benefits

Accelerate the development of new designs via simulations

Each model is designed and implemented in virtual environment

✦ a functional minimalist design offered to our customers

*“PLYGear wanted to have a better approach to furniture design for a complex environment by mixing ideas with passion and engineering precision. The most characteristic of all PLYGear items is that thanks to the precision of the modern processing methods the assemblies are made extremely reliable and impeccable.*

*” Borislav Georgiev, MS in Engineering, Technology Developer @PLYGear*

### Full story:



Croatia



## HPC-based Stabilization for Additive Manufacturing

### Company

Mikrotvornica d.o.o. specializes in high-quality prototype and product production using advanced technologies, with a strong focus on additive and digital manufacturing.

### Challenges & Solution

The aim of the project is to reduce heat-induced deformations in 3D-printed objects. These deformations can significantly affect the quality and functionality of the final product. Based on computational fluid dynamics simulations performed using the HPC infrastructure, through an iterative processes and fine-tuning, an improved 3D printer assembly was created. In addition, the additive manufacturing process was improved by outlining and providing complete control over the parameters that affect the dimensional stability of 3D printed products.

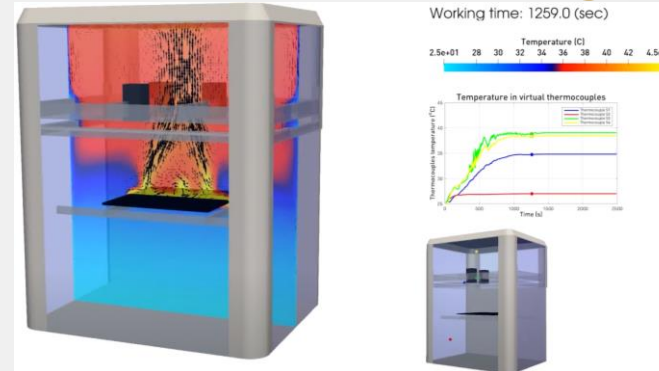

CFD-based tuning process.

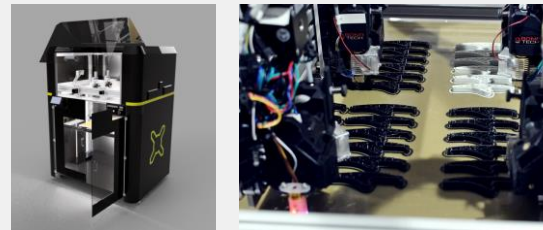

Modified 3D printer and object printing.

### Benefits

- ✓ Shorter delivery times by up to 50%.
- ✓ Reduction of up to 30% in production costs.
- ✓ Savings of €150.000,00 over a period of three years.
- ✓ Increase in sales by up to 30%.

*“In cooperation with the members of NCC Croatia (RBI), we were provided with professional support and extensive experience with regards to the application of high-performance computing in order to improve 3D printing characteristics and capacities.”*

**Nikola Blažević, CEO @Mikrotvornica**

### Full story:

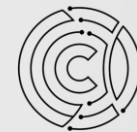

HRVATSKI CENTAR  
KOMPETENCIJA ZA HPC



## Dynamic Fluid-Object Interactions During Motion

### Company

AITAC d.o.o. is a local subsidiary providing yacht, naval, cruise ship, marine & offshore engineering and PLM services in shipbuilding and offshore industry.

### Challenges & Solution

Simulating the movement of submerged objects in a fluid-filled tank can be a challenging task. The dynamic interaction introduces a variety of problems e.g. sloshing and potential spillage, all of which must be accurately characterized and effectively mitigated. The use of high performance computing is indispensable for the successful execution of these computational fluid dynamics simulations.

A carefully crafted plan for the optimal motion of objects is proposed. This plan represents a delicate equilibrium between the minimization of waiting times and the prevention of water spillage, and as such improves the overall system performance.



Simplified / representative problem concept.

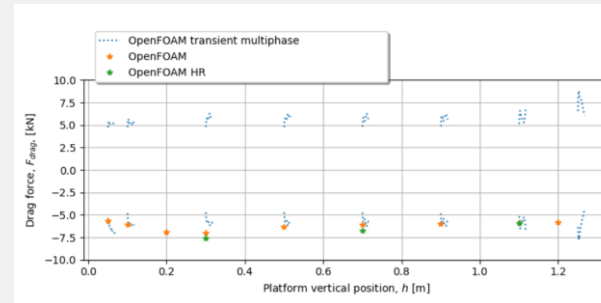

Forces at relevant locations.

### Benefits

- ✓ Optimized system performance by minimizing waiting times
- ✓ Facilitated the rapid exploration of novel design possibilities
- ✓ Optimal movement plan contributes to safer and more reliable system

*“We were interested in the displacement of the water during the movement and were unsure of the bottom's impact on the flow and the force due to the negative pressure. Given that this is a component of a larger system, we needed a solution that would ensure uninterrupted and optimal operation.”*

**Domagoj Borucinsky, Engineer @AITAC**

### Full story:

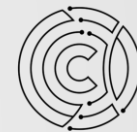

HRVATSKI CENTAR  
KOMPETENCIJA ZA HPC



## Digital Twin Framework for Hydrofoil Optimization

### Company

Marotti Windsurfing d.o.o. is a company founded by the two-time windsurfing champion. MWSC is dedicated to the development and production of windsurfing equipment.

### Challenges & Solution

In close cooperation with IIT d.o.o., specialized equipment and software were developed to ensure precise measurements of fluid data. A methodology based on reverse engineering and digital twin technology was developed to design an optimized hydrofoil. The mold creation process saw collaboration with members from the Academia and Bex d.o.o., resulting in a robust approach to aluminium mould production. State-of-the-art techniques were employed to produce and thoroughly test new hydrofoil prototypes.

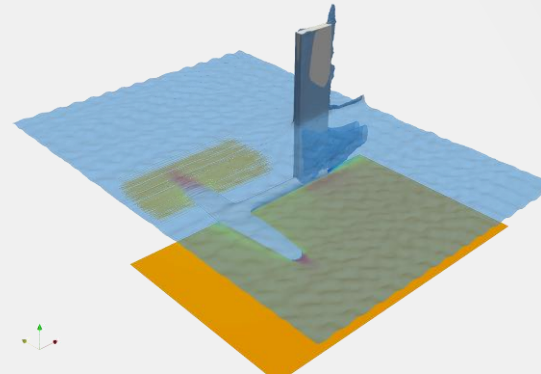

CFD-based design optimisation



Hydrofoil mold used to create a prototype design.

### Benefits

- ✓ Enhanced hydrofoil windsurfing performance.
- ✓ Competitive and industrial advantage (improved products).
- ✓ Industry/company growth.
- ✓ International recognition.
- ✓ Futureproofing.

*"I am grateful for the accessibility, willingness, and enthusiasm in order to jointly achieve success. Our goal is to create a so-called 'speed foil' hydrofoil with which we will attempt to break the speed world record. I am confident, based on current results, that we will achieve this."*

**Enrico Marotti, CEO @Marotti Windsurfing**

### Full story:

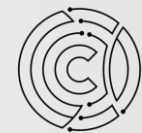

HRVATSKI CENTAR  
KOMPETENCIJA ZA HPC



Cyprus

## Automated Data Anonymisation Framework

### Company

Hello Radius is an AI-powered hiring platform that accelerates and secures recruitment by using skill-matching and anonymisation technology to reduce bias and protect candidate data. Designed for HR teams, it streamlines candidate sourcing, screening, and shortlisting to make hiring faster, fairer, and more cost-effective.

### Challenges & Solution

Hello Radius needed a reliable way to anonymise sensitive data in candidate CVs, such as names, addresses, and phone numbers, to ensure compliance with data privacy standards and reduce hiring bias. NCC Cyprus provided consultation services to Hello Radius, focusing on a range of tools for effective data anonymisation, such as Microsoft Presidio and LangChain.

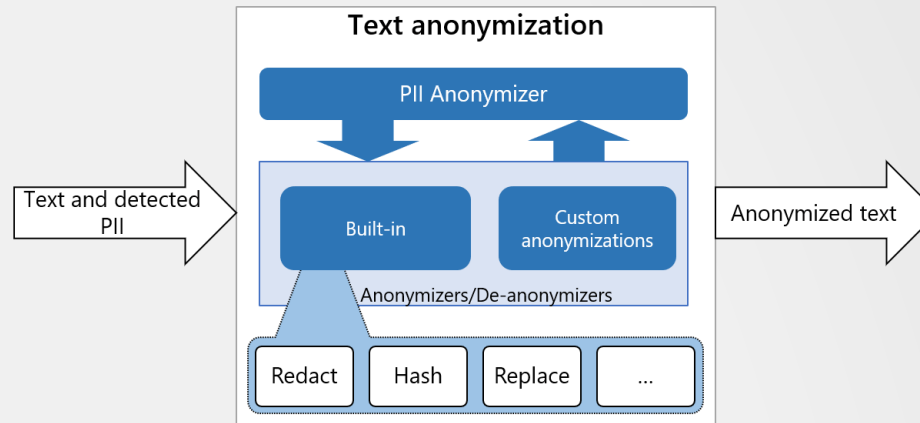

Architecture of Microsoft Presidio's Anonymisation Process.  
Figure from <https://microsoft.github.io/presidio/anonymizer/>

### Benefits

- ✓ Enhanced data privacy compliance
- ✓ Efficient and scalable anonymisation
- ✓ Improved data integrity for decision-making
- ✓ Reduced hiring bias

*"This project strengthened our technical capabilities, enhancing data privacy compliance, reducing risk and supporting our mission to make AI-powered recruitment safer and fairer. The team's expertise helped us overcome a key AI development challenge with benefits extending beyond our immediate use case."*

**Dionysis Kastellanis, CEO & Technical Lead @HelloRadius**

### Full story:



## Analysis of MRI images using HPC

### Company

The German Medical Institute is a leading medical center in Cyprus, focusing on patient-oriented healthcare, high quality education and research and utilising the latest medical technology.

### Challenges & Solution

The German Medical Institute is handling large amounts of medical datasets, whose complexity and volume necessitate substantial computational resources. NCC Cyprus facilitated access to HPC resources to enable efficient handling of medical images. The consultation also involved methodologies for processing MRI data, optimising data preparation for multicore processing and setting up a PyTorch environment for deploying deep learning models for medical image analysis. The provided solution has led to optimized data transfer, efficient data loading and pre-processing, and enhanced resource utilization.

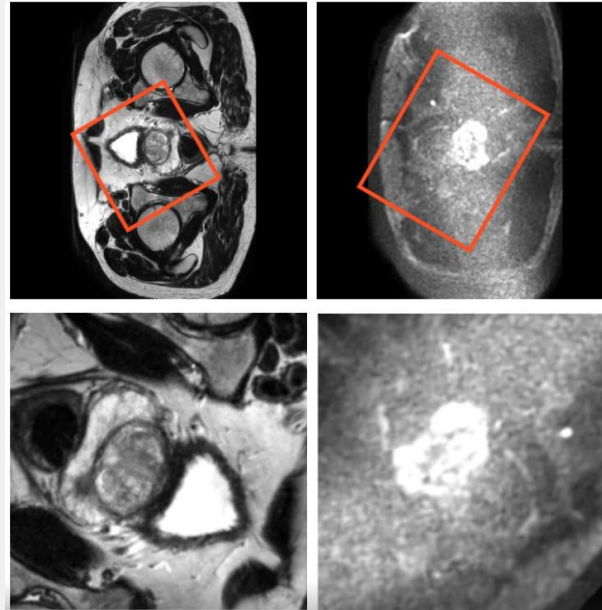

Easier processing of medical images through the use of HPC

### Benefits

- ✓ Significant speed up in processing MRI data
- ✓ Consistency and reliability in data handling
- ✓ Optimised data transfer, processing and storage
- ✓ Enhanced resource utilization
- ✓ Robust model development

*“The synergy between German Medical Institute and CaSToRC has been instrumental in developing cutting-edge AI algorithms that pioneer analysis of Magnetic Resonance Images (MRI). The combination of GMI’s clinical expertise and extensive datasets, along with CaSToRC’s technical expertise and state-of-the-art facilities greatly accelerates such endeavours “*

**Yiannis Roussakis, Head of Medical Physics Education and Research programme, German Medical Institute**

### Full story:



## Automating literature search using RAG system



### Company

Medochemie Ltd. is specialized in the development, production, and distribution of generic pharmaceutical products. Also, Medochemie has established itself as a leader in the pharmaceutical field, particularly in Europe, Africa, and Asia.

### Challenges & Solution

To ensure compliance with health and safety guidelines, Medochemie needs to conduct extensive literature reviews when developing new products, which is time-consuming and repetitive. NCC Cyprus consulted Medochemie on how to automate this process to save time and optimize product development. A Retrieval-Augmented Generation (RAG) system was suggested to allow the company to import all relevant documents into the system. The RAG system has the capability to process the documents and automatically answer the protocol's required questions, ensuring that all essential information is correctly extracted and applied to the development process.

### What is the polymorphism of Active Substance?

RAG System	Medochemie
 Active Substance (AS) is classified as a BCS Class 4. AS has 4 non-solvated polymorphs, denoted Polymorph I, II, III, and IV. These crystal modifications of AS are distinguishable by X-Ray Powder Diffraction. Extensive polymorph screening has confirmed the existence of several crystal modifications of AS.	 Extensive polymorph screening has confirmed the existence of several crystal modifications of AS. There are 4 non-solvated polymorphs (Polymorph I, II, III and IV) and a number of solvated crystalline modifications that are clearly distinguishable by X-Ray Powder Diffraction.

Comparison between Answers Provided by the RAG System and Expected Responses from Medochemie.

### Benefits

- ✓ Accelerates product development by automating repetitive tasks
- ✓ Ensures consistent and accurate compliance to guidelines
- ✓ Scales easily to handle increased document volume
- ✓ Allows resources to focus on strategic and innovative work

*“Medochemie has run a pilot program with NCC using RAG system for a pharmaceutical product under development. The outcome of this study is very encouraging especially to the matter related to the literature search that needs to be conducted for the drug substances in the initial stages of the development. We shall continue our efforts and expand the use of RAG system in the drug product aspects”*

**Dr Charikleia Souli (MSc., PhD), New Products Development Senior Manager @Medochemie**

### Full story:



## A DL-Driven Stereo Vision System for Fish Weight Estimation in Offshore Aquaculture Cages

### Company

Kimagro Fishfarming Ltd. (Levantina Fish) specializes in sustainable aquaculture of Mediterranean species like sea bream, focusing on innovation and environmental care.

### Challenges & Solution

Manual fish weight monitoring is labor-intensive, time-consuming, and stressful for fish. To overcome these challenges, Kimagro Fishfarming Ltd. partnered with NCC Cyprus to develop an automated, non-invasive solution. A stereo vision system combined with Deep learning (DL) was created to estimate fish weight using RGB-D images and key point detection, achieving very high accuracy. Trained on only 250 annotated samples and 9 minutes of footage, the system is efficient, portable, and supports sustainable aquaculture through reduced manual handling and improved monitoring and scalability.

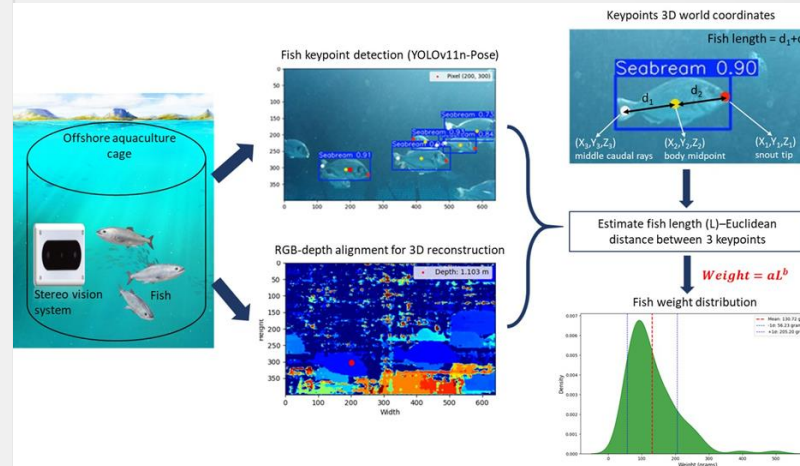

### Benefits

- ✓ Practical and adaptable tool for precision aquaculture applications
- ✓ Automatic fish estimation, minimizing manual handling and fish stress
- ✓ Boosts sustainability and efficiency in fish farming operation

*“When driven individuals with diverse career backgrounds come together with a shared vision for success, open new doors to innovation and promising transformation. In today’s fast paced world, it is crucial to embrace the changes that come with technology that will help shape the future for sustainable aquaculture.”*

**Antonis Kimonides, Owner, Managing Director @Kimagro Fishfarming Ltd.**

**Full story:**



## From Data to Decision: HPDA and HPC Reveal the Value of Cooling in Dairy Farming

### Company

Vettaky Ltd is a dairy consultancy in Cyprus, specializing in holistic feeding programs and animal welfare. Combining scientific expertise with practical field experience translates research into innovative solutions fostering high animal health, fertility, welfare standards and productivity tailored to individual farm situations.

### Challenges & Solution

Dairy farms in Cyprus are increasingly affected by heatwaves that reduce milk yields and threaten profitability. Yet, quantifying the economic return of cooling systems is difficult. Observational farm data are confounded by biological variability and environmental effects. Using High-Performance Computing and advanced Bayesian methods, a hierarchical model was developed that quantifies how cooling systems mitigate heat stress in dairy cattle. Running on the local HPC infrastructure, Cyclone, enabled efficient sampling of large posterior distributions, ensuring robust, data-driven results.

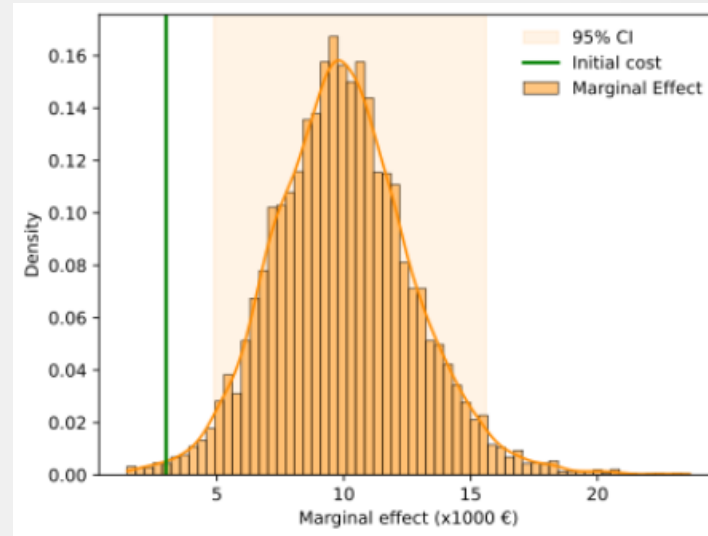

Figure: Posterior probability density of the marginal effect of the cooling system. The analyses showed that the installation cost is well below the 95<sup>th</sup> percentile indicating a clear positive outcome for the farm

### Benefits

- The use of cooling system resulted in approximately 0.31 tonne gain in milk yield per cow per year
- HPC-enabled Bayesian modelling for reliable impact estimates
- Scalable tool for climate-resilient agricultural planning

### Full story:

*“This collaboration enabled us to translate complex, multi-parameter farm data into actionable insights, improving our ability to make evidence-based management decisions.”*

**Vasilis Symeou, Vettaky Ltd**



Czechia

## Tool to fight criminality more effectively

### Company

The Police of the Czech Republic are an armed security force established by the National Council Act of 21 June 1991. The Police of the Czech Republic serves the public.

### Challenges & Solution

The practical part of the Maps of the Future II project aimed to use crime data to develop and test new procedures and tools for more effective crime fighting and more targeted, efficient, and thus cheaper use of resources (personnel, financial, and material).

Models designed to predict crime and socio-pathogenic phenomena throughout the Czech Republic were successfully developed and tested. The possibility of running memory and computationally demanding tasks in parallel using dedicated graphics cards proved crucial, allowing individual experiments to be reduced from days to hours.

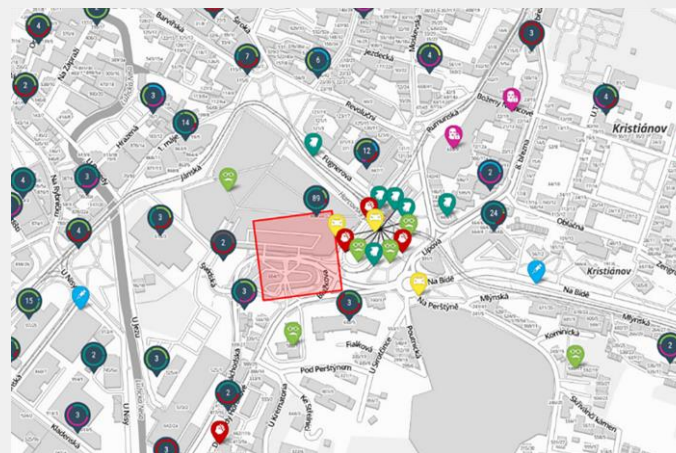

Photo provided by the Police of the Czech Republic.

### Benefits

- ✓ The criminality prediction model training time was reduced several fold
- ✓ The training done on the GPU nodes of the Karolina cluster was shown to be effective
- ✓ The solution will help the Police of the Czech Republic increase the efficiency of their patrol planning.

*"I am very pleased that the employees of the Police of the Czech Republic are actively involved in the search for innovations and solutions to one of the current topics in the internal security of the Czech Republic, which is the effective use of available resources (both human and material)."* **genmjr. Martin Vondrasek,**  
**Police President**

### Full story:



## Use of Bulk Simulation in the Development of a Rail Freight Wagon

### Company

Advanced Engineering is a company that focuses on computer simulations, structural analysis and optimisation of structures, and multi-physics modelling and simulation.

### Challenges & Solution

End customers and users asked for a guarantee for the time required to unload each wagon during unloading, and the development team needed to make sure that the geometry of the hoppers and funnels would ensure the complete discharge of bulk material without it being stuck to the walls.

The solution can simulate the interaction of the bulk material with the structure, the ability to compare multiple design options, and the ease of analysing the behaviour of different grain types under various external conditions such as temperature and humidity.

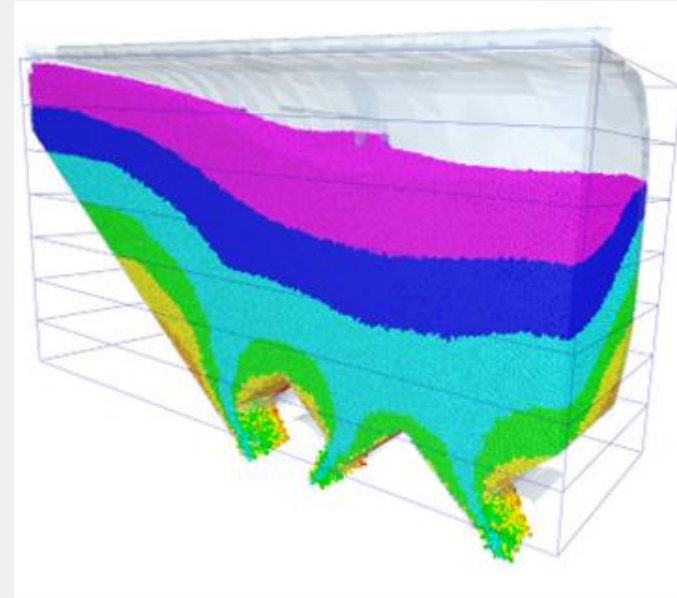

Ongoing simulation of emptying a freight wagon box – one-quarter simulation model.

### Benefits

- ✓ Time and costs savings through numerical modelling and simulations
- ✓ The ability to simulate the interaction of the bulk material with the structure
- ✓ The ability to compare multiple design options

*“The advantage of computer simulations of bulk material movement for this problem over physical testing is that the cost of hiring grain silos and grain costs are eliminated.”* **Tomas Curda, Business Development Manager, Advanced Engineering, s.r.o.**

### Full story:



## Medical Image Processing

### Company

University Hospital Ostrava is a state-funded organisation established by the Ministry of Health of the Czech Republic. The primary purpose of this organisation is to provide health services.

### Challenges & Solution

The main goal of the cooperation was to deploy and test a tool providing remote automatic tissue segmentation from patient image data obtained from computed tomography (CT) or magnetic resonance imaging (MRI) on supercomputers at IT4Innovations National Supercomputing Center.

The automated segmentation process can be applied to specific tissues of real interest to the physician, and the resulting model can be further used to plan healthcare tailored to the individual patient.

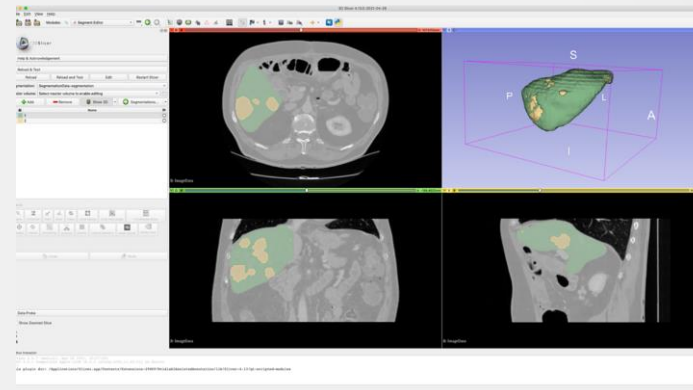

3D Slicer working environment with possible output obtained by automatic segmentation on HPC cluster.

### Benefits

- ✓ The time of the segmentation process is reduced by automation
- ✓ Spared time can be used for the physician's benefit
- ✓ The automated segmentation process can be applied to specific tissues of interest to the physician

*“Using this toolkit is beneficial for both patients and physicians, as automation allows us to achieve high-quality image reconstructions in a fraction of the time and with minimal effort.”* **Jan Roman, MD, University Hospital Ostrava**

### Full story:



## Launch of the Vaccination Centre

### Company

This case has been handled together with the University Hospital Ostrava, Moravian-Silesian Region, Statutory City of Ostrava and Faculty of Medicine of the University of Ostrava.

### Challenges & Solution

In March 2021, IT4T and the NCC in HPC collaborated on a joint project to build a large-scale vaccination centre in Ostrava, which was commissioned at the Černá louka site.

Our team created a simulation of the vaccination center's hall. This simulation detects critical vaccination centre points at times of high workload. Several bottlenecks in the original design, such as the waiting room after vaccination and the exit confirmation printing.



A consultation before the vaccination process.

### Benefits

- ✓ The vaccination center can be designed efficiently in short period of time. Accurate detection of critical points and it's redesign.
- ✓ The required number of operator and staff positions for each station were identified.
- ✓ The simulation also determines how many patients can be in the vaccination centre at any one time, at different stages.

"I appreciate the efforts of all the partners who have been and continue to be involved in constructing the vaccination centre. It is good to note that an important element in the design of such a centre was the supporting simulation, which was developed by scientists at IT4I and without which the testing of the capacity of the centre would have taken many times longer."

**Ivo Vondrak, Governor of the Moravian-Silesian Region**

**Full story:**



# Computational Simulations for Emission Reduction in Combustion Plants

## Company

The ORGREZ company provides services and supplies in several specific fields of power engineering, thermal engineering and ecology, generally in the processes of fuel energy conversion and electricity production and distribution.

## Challenges & Solution

The main objective was to determine whether Computational Fluid Dynamics simulations could be used for the fast and efficient description of the selective catalytic reduction technology (SCR) catalysis process and, therefore, as a tool to mediate the design of a computational application for the design of this technology.

The use of numerical modelling and simulations will make the process more efficient, and faster and, most importantly, extend the application possibilities of this process, which will enable subsequent optimization of the designed solution and, thanks to high-performance computing, it will be possible to complete these simulations in a relatively short time.

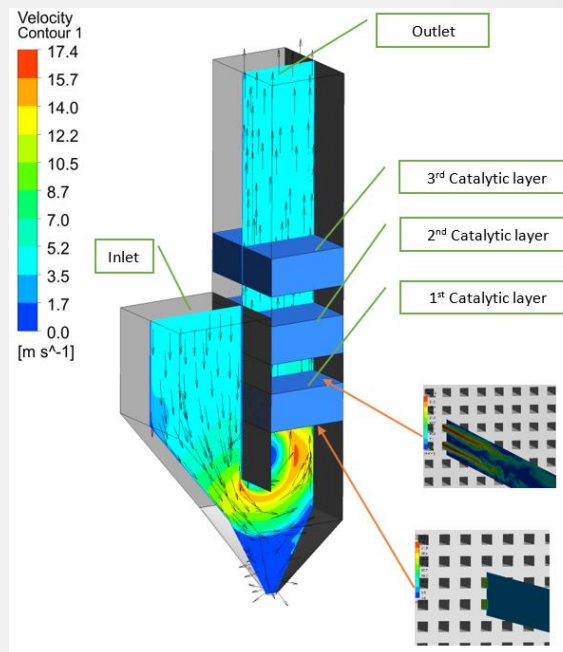

CFD simulation of SCR process.

## Benefits

- ✓ Confirmation of the applicability of CFD for SCR design and optimization
- ✓ Time and costs saving due to speed up of SCR design process
- ✓ Environmental impact due to optimised SCR design leading to increase of NOx emission reduction

*“By speeding up the design process of the SCR technology, time and cost savings are achieved and, in addition, the optimised SCR technology design leads to more effective NOx emission reduction and extended technology lifetime, which has a positive impact on the environment.”*

**Vojtech Vavricka, Managing Director of the ORGREZ Division for Ecology Systems**

## Full story:



## Numerical simulation of Butterfly Valve closing

### Company

The Armatury Group specialises mainly in the production of valves, technological units, and related services. The main advantages of their production are their wide range of goods, quality of production and adaptation to customer requirements.

### Challenges & Solution

In this collaboration, the primary focus was creating a proof-of-concept, by comparing available Computational Fluid Dynamics Simulation (CFD) approaches to moving objects in fluids.

A comparison of four CFD methods was successfully conducted, providing an overview of the requirements and limitations of each method, as well as the accuracy of the results. The simulations were carried out on a “simplified” flap valve, designed not to limit the use of any of the above-mentioned methods.



Overset mesh method.

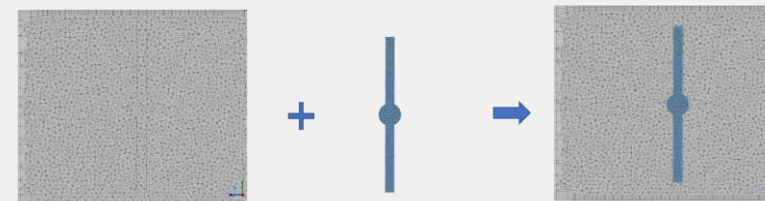

Immersed body method.

### Benefits

- ✓ Future computation models will be built with higher accuracy results.
- ✓ The simulations will be completed faster, resulting in cost savings.
- ✓ When many simulations are required, a supercomputer is an advantageous tool.

“The use of HPC infrastructure will not only allow computational models to be built with higher accuracy results but also help to complete these simulations in a reasonable time, leading to cost savings. In addition, using supercomputers is advantageous for design optimization when many simulations need to be performed.”

**Lukas Kusnir, Research and Development Director of Armatury group**

*Full story:*





## Realistic architectural visualisations using supercomputers

### Company

INFER WAY focuses primarily on designing buildings, public spaces, preparing architectural and urban studies, and designing interiors. In addition to civil and residential buildings, the company also creates single-family houses and various interiors.

### Challenges & Solution

The company wanted to develop and verify suitable procedures for processing input architectural data that would enable the generation of visually attractive outputs.

Creating procedures to appropriately modify and augment the 3D scene was necessary to generate photorealistic quality video footage. Furthermore, the scene was modified to allow interactive exportation in VR. In both cases, a path trace rendering was used. A supercomputer was used to achieve fast and accurate rendering outputs.

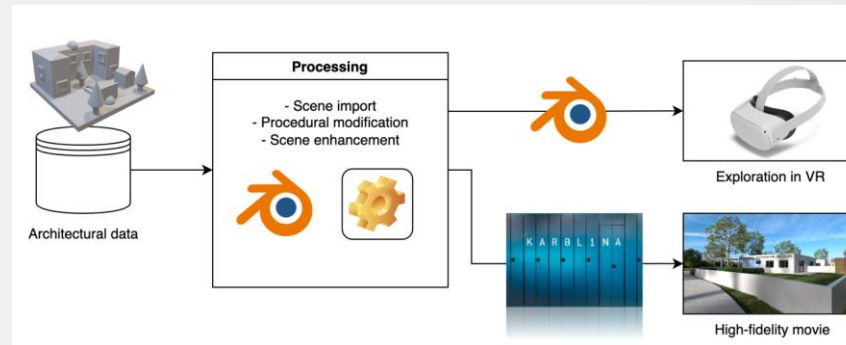

Processing workflow applied to architectural data.

### Benefits

- ✓ Visualisations of the building design can be highly immersive.
- ✓ Improvement of the design ideas explanation between the designer and the customer.
- ✓ Time and cost savings.

“Thanks to HPC, it is possible to achieve high visual quality in a fraction of the time compared to rendering on a standard workstation or a set of several workstations. Ideas can be better communicated with the customers, and due to the integration of VR technology in the process, resulting visualisations can be highly immersive.”

**Martina Perinkova, CEO of INFER WAY s.r.o.**

### Full story:



## Using supercomputers to create 3D tissue models for visualization

### Company

Misterine's innovative AR and VR solutions enable better visualisation and education through immersive 3D experiences. Their Studio & App help users to effortlessly create, edit, and play AR manuals for a better understanding of complicated manual procedures.

### Challenges & Solution

Misterine wanted to create 3D tissue models for visualisation using the supercomputer. Incorporating the new features into Misterine's existing workflow and ensuring seamless integration with NCC's workflow while maintaining data integrity presented a significant challenge.

NCC has offered methods to enhance Misterine Studio's software capabilities to showcase medical tissues in AR and enable workflow execution from the command line.

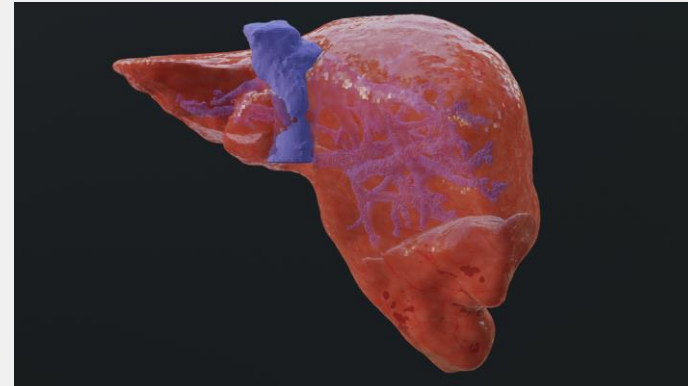

A 3D liver model that may be viewed in AR/VR.

### Benefits

- ✓ For example, tissue models can be used for AR training from medical image data.
- ✓ Medical professionals and researchers can study and analyse the tissue more precisely.
- ✓ The solution will help optimise workflows, reduce complexity, and render realistic images using AR and VR devices.

**"Thanks to using supercomputers, it has been possible to reduce the time of AI model training from computed tomography (CT) datasets. This will help Misterine with advanced data processing capabilities with deep learning."**

**Martin Klima, CTO of Misterine s.r.o.**

### Full story:



**EURO  
CZECHIA**



## Neural networks in the steel industry

### Company

ITA technology & software company supplies know-how and software solutions to leading major producers of rolling equipment, technologies, and control systems. Many of their software solutions have been successfully installed in rolling mills worldwide.

### Challenges & Solution

Among the objectives of the collaboration was to investigate the possibility of using machine learning and neural networks to predict the accurate cooling parameters in steel rolling manufacturers' processes.

Having the correct parameters is essential for ensuring the final product's quality. The aim is to replace the need for manual correction with automatic correction based on AI methods.

The solution was analyzed and verified if the predictions generated by the ML models can enhance the methods currently used by ITA.



Illustration of the steel sheet cooling process.

### Benefits

- ✓ Artificial intelligence allows more accurate temperature calculations.
- ✓ An automated correction based on AI can calculate the estimated belt temperature after cooling more accurately and make the entire cooling process more efficient.
- ✓ Time and, therefore costs can be saved.

“The collaboration with IT4Innovations and the use of machine learning methods have been very beneficial for us, as the deployment of artificial intelligence allows for more accurate temperature calculations. Among the time and cost savings, I would also like to highlight the positive environmental impact thanks to the optimized cooling process.”

**Daniel Hajduk, ITA, spol. s r.o. Executive Manager**

### Full story:



## Estimation of product defects using supercomputers

### Company

The ING Corporation develops, designs, and manufactures medical devices using modern technologies such as 3D printing, CNC machines, and advanced materials. It is one of the leading companies on the Czech market in prosthetics.

### Challenges & Solution

The main goal was to develop and verify effective procedures for analysing the shape of manufactured products, especially focusing on identifying possible inaccuracies. Implementing machine vision instead of manual check by an expert can offer a significantly more efficient and accurate approach.

Using descriptive points and relevant information that describe the product, the solution algorithm calculates the manufacturing error rate.



The first column shows two different types of product deformation. As you can see, the shape of the product is damaged. The next column shows the final product that meets the quality standards.

### Benefits

- ✓ Algorithm calculates the manufacturing error rate by comparing the final product to its proposed construction.
- ✓ Verification of the product's shape if it meets the standards.
- ✓ Proposed solution can make production more efficient thanks to the possibility of detecting non-conforming products.

**“The proposed solution can make production more efficient thanks to the possibility of detecting non-conforming products. In the next phase, it would be possible to use the results to identify problematic parts of the product design itself. It would further improve the efficiency of the entire design-manufacturing process.”**

**Jiri Rosicky, CEO of ING corporation**

### Full story:



## System for intelligent identification of air pollution sources

### Company

ENVitech Bohemia focuses on offering comprehensive services in the field of environmental monitoring, especially of air - the company's main focus is the measurement of concentrations of pollutants. They supply a comprehensive assortment of means for monitoring air quality, including management systems.

### Challenges & Solution

The aim of the cooperation between ENVitech and the VSB – Technical University of Ostrava institutes CEET and IT4Innovations was the implementation of the “Intelligent Air Pollution Source Identification System” (IIS) based on the principle of an online model of short-term values of concentrations of selected, health-relevant substances.

A comprehensive system for monitoring emission loads and software for evaluating and interpreting air pollution was acquired, emphasizing effective use for strategic decision-making in state administration, self-administration, and industrial resource management.

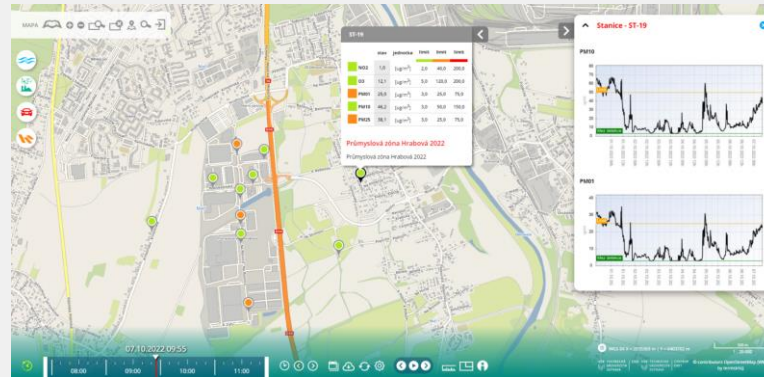

View of the software evaluating and interpreting air pollution.

### Benefits

- ✓ Moravian-Silesian Region and the Ministry of the Environment have obtained a tool for fast, large-scale and cheap measurements of air pollution changes.
- ✓ Easy-to-use graphical interface for an average users integrating data from different thematic areas.
- ✓ Plug&Play system architecture enabling the simple integration of new sensors and automatic data processing and visualisation.

“In order to evaluate the effectiveness of the decarbonization of the region and the impact of low-carbon technologies on the environment and society, it is necessary to assess the state of air quality before and after their implementation. Therefore, the creation of an intelligent identification system of air pollution sources was absolutely necessary.”

**Stanislav Misak, Director of the CEET at VSB – Technical University of Ostrava**

**Full story:**





## Easy and secure access to HPC infrastructure for scientists through HEAppE

### Company

Politecnico di Milano is a public scientific-technological university that trains engineers, architects, and industrial designers.

### Challenges & Solution

During the COVID-19 pandemic, the university wanted its scientists and researchers to access HPC infrastructure easily without installing additional software. The solution should allow them to continue their research on possible cures for COVID-19.

The collaboration led to developing a client environment application based on the web-based interactive computing platform Jupiter Notebook. It allows for the creation and management of HPC executions using HEAppE Middleware. Additionally, the client environment offers the choice of a language (C# or Python), depending on the research activity.

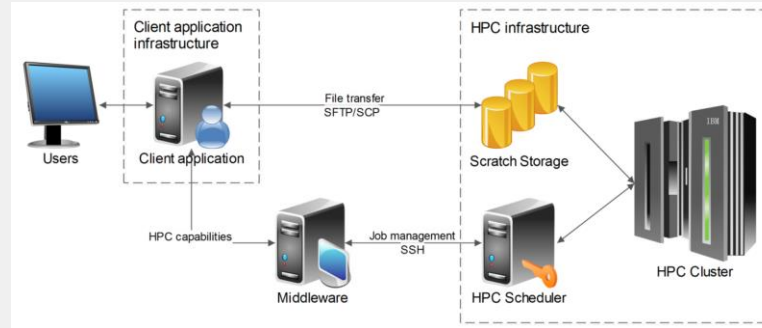

Visualisation of the connection between the user and HPC Cluster through the client environment.

### Benefits

- ✓ The solution enables to continue research using HPC infrastructure remotely even during isolation.
- ✓ Can help further accelerate the computational process in case of future pandemics.
- ✓ Installation of additional software is not necessary.
- ✓ Choice of a language is possible.

“Within the project Exscalate4COV, we virtually screened more than 70 billion molecules as possible drugs against Sars-CoV-2. This is where supercomputers make all the difference, facilitating the rapid selection of only the most promising molecules for subsequent phases of the drug discovery pipeline.” **Gianluca Palermo, Professor at Politecnico di Milano**

Full story:



## Weed detection – weeding machine

### Company

Family-run tech startup Ullmanna develops an agricultural weeding machine that recognizes the target crop using machine learning and enables in-line weed control.

### Challenges & Solution

The main challenge was identifying crops automatically, in this case sugar beets, from weeds. By recognizing the crops, the weeding machine will be able to remove the weeds without damaging them.

Direct deployment on the weeding machine places additional demands on the technology regarding HW and recognition speed.

By using machine learning, we were able to solve this challenge. To accomplish this goal, a neural network was created and trained.



Agricultural weeding machine device for recognition of the target crop from weed.

### Benefits

- ✓ The weeds can be removed while not damaging the crop grown.
- ✓ Farming activities without the use of chemical sprays.
- ✓ Positive impact on the environment and society.
- ✓ Enables an increase in food production without the usage of pesticides.

**“Our intended product has a significant positive impact on the environment and society – it enables an increase in food production without the use of pesticides that negatively affect both the environment and human health.”**

**Martin Ullmann, Chief Executive Officer, Co-founder, Ullmanna**

**Full story:**



Estonia

## An accurate AI-based Cloud Mask Processor for Sentinel-2

### Company

KappaZeta is a remote sensing company with expertise in using radar satellite data, incorporating it with optical satellite data and providing some of the most accurate AI models on the market.

### Challenges & Solution

Cloud masking is an essential step for the pre-processing of optical satellite imagery. KappaZeta addresses the problem by introducing KappaMask, an AI-based cloud and cloud shadow masking processor that uses a large convolutional segmentation model. Faster model convergence during training can be achieved by using larger batch sizes of the training data, which means more GPU memory is needed.

KappaMask was trained on an open-source dataset and fine-tuned on a Northern European terrestrial dataset which was labelled manually using the active learning methodology.

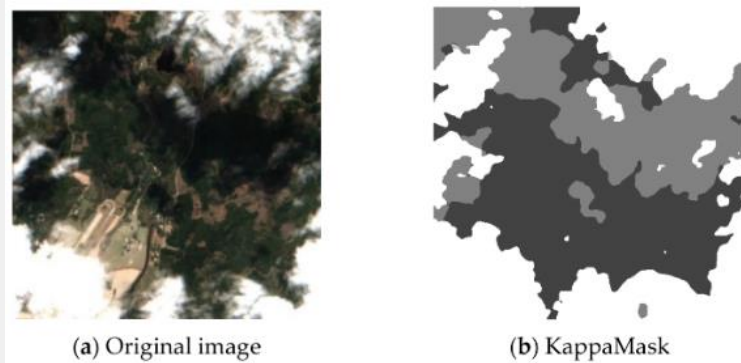

Comparison of L2A prediction output for a 512 × 512 pixels sub-tile in the test dataset.

(a) Original Sentinel-2 L2A True-Colour Image; (b) KappaMask classification map.

### Benefits

- ✓ Reliable cloud mask processor for Northern Europe region, which is compatible with ESA Sentinel-2 L2 processing chain
- ✓ Creation of high quality reference dataset for future developments
- ✓ Innovative application of deep learning techniques in cloud masking

*“We compared KappaMask v2 with other cloud masking processors including Sen2Cor, Fmask, MAJA, IdePix and S2Cloudless on the challenging and diverse test set. KappaMask v2 demonstrated exceptional performance reaching the highest accuracy and outperforming all the above-mentioned methods.”* **Tetiana Shtym, machine learning engineer @ KappaZeta**

### Full story:



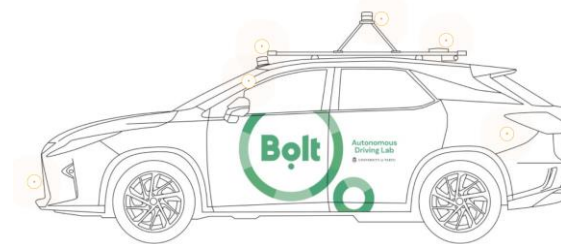

## Self-driving Technology Research in partnership with the University of Tartu

### Company

Bolt is an Estonian mobility company that offers vehicle for hire, micro mobility, car-sharing, and food delivery services headquartered in Tallinn and operating in over 400 cities in over 45 countries. In partnership with the University of Tartu, the company develops self-driving technology for a Level 4 autonomous car.

### Challenges & Solution

Autonomous cars acquire up to 357 GB/hour of data during test drives. Autonomous car engineers needed a system to store and easily access those test logs.

Acquired test logs are copied to HPC storage, into appropriately guarded directory. Regularly cron job processes those log files into metadata stored in MongoDB database. Processing is distributed over cluster and happens in parallel. Longest logs can take up to 24 hours to process, so processing them sequentially would be very time-consuming. On top of MongoDB sits custom-made application that allows filtering of test sessions and browsing them using Webviz visualization tool. Visualization tool accesses the raw sensor data from HPC storage.



Lexus RX450h equipped with the sensors that are a prerequisite for basic autonomy.

### Benefits

- ✓ Custom database application and visualization tool enables easy analysis of the logs
- ✓ Thanks to distributed processing in the cluster the metadata about the drives usually shows up already next morning
- ✓ Thanks to petabytes of storage at the HPC Centre, the company can keep all the data they need

### Full story:

*"Thanks to custom database application and visualization tool the team members can easily analyze the logs and share their findings with each other"* **Tambet Matiisen, Operations coordinator @Bolt**



## Machine Translation Post-Editing

### Company

Luisa Tõlkebüroo OÜ is the biggest translation agency in Estonia. The company offers more than 50 services – including sworn translation, simultaneous and consecutive interpretation, layout work, machine translation and post-editing, subtitling and localisation.

### Challenges & Solution

The company needed a custom-made machine translation system to reduce the time of translations. As the company had no previous experience neither in natural language processing nor in machine learning, they collaborated with the TartuNLP team. Training of the machine translation model was conducted by using University of Tartu HPC centre's Rocket cluster.

Once the models were trained, the company considered different options for deployment. Their initial plan was to invest in their own infrastructure but soon they realized that it would not be justified for their use case and the TartuNLP group deployed the models alongside other services in the cloud.

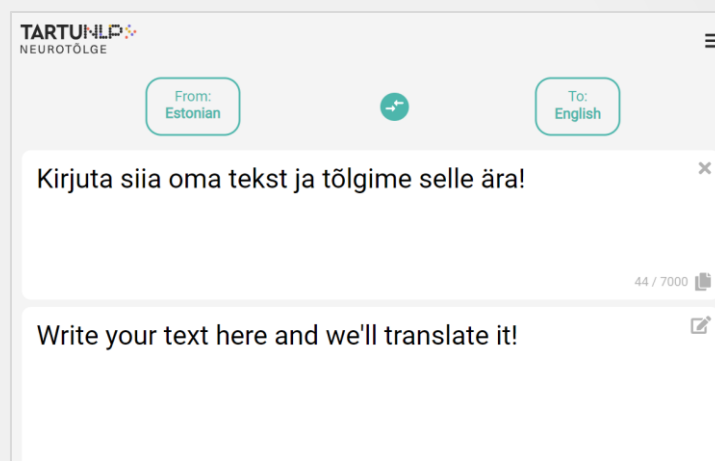

Screenshot of the translation engine developed by TartuNLP.

### Benefits

- ✓ Neural machine translation systems were built for 4 language pairs and several text domains
- ✓ The company enjoyed lower deployment costs and did not have to worry about maintaining their own hardware
- ✓ The innovative translation tool helps to save valuable time and human resources

### Full story:

*"Thanks to rapid advances in the technology and our extensive translation memory, we are able to offer our clients machine translations with post-editing in a range of language combinations and on a range of topics."* **Anna Räbokon, Customer**

**Relations Manager @Luisa Tõlkebüroo OÜ**



# Construction (3D Scanning)



# GSCAN

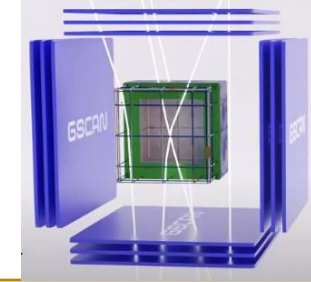

**EURO<sup>2</sup>**

## Cosmic Ray-based Solutions for 3D Imaging

### Company

GScan was founded in 2018 to revolutionize inspection, security and medical scanning markets using Muon Flux Technology (MFT). GScan, as the pioneer of MFT having unique IP, tech & sales know-how in the field, is developing a new generation of Non-Destructive Testing (NDT) scanners and tomography systems for infrastructure management applications.

### Challenges & Solution

To keep the surrounding environment safe and ensure their longevity, careful assessment, maintenance and investment plan is required. However, currently there is no efficient way of obtaining the information required for more efficient use of assets and reducing risks for critical infrastructure.

Using cosmic ray tomography, the technology monitors particle trajectory changes, extracting vital statistics about material and shape. This data is transformed into 2D and 3D visualizations, including internal and external geometries and chemical composition. The comprehensive delivered output provides in-depth insights into the objects and materials under scrutiny. HPC plays an important role in translating the collected data into visualizations.

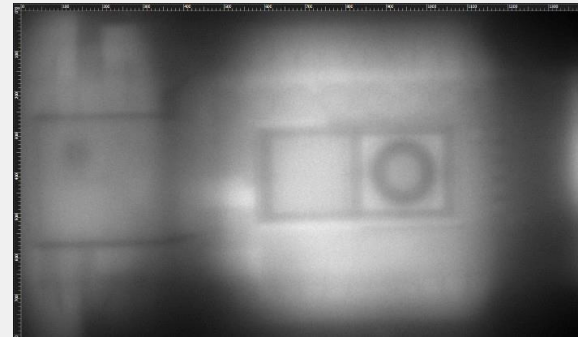

A reconstructed model of a temporarily decommissioned nuclear submarine. The horizontal plane slice covers 15x9 m area, which in total consists of 135 0000 points of interest (pixels), and is one out of 900 slices that were processed during the post-processing of measurement

### Benefits

- ✓ Acceleration of data processing and reconstructions.
- ✓ Application of a broader range of algorithms during the post-processing.
- ✓ Provision of more reliable data about critical infrastructure for a safer world.

*«With time and space related digital data in terabytes, the detailed process of reconstruction enables us to see inside of structures what was not possible before.» Sander SEIN, PROJECT MANAGER GSCAN*

**Sander SEIN, PROJECT MANAGER GSCAN**

### Full story:



# Finland

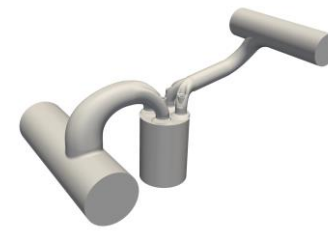

## LUMI supercomputer impressed Wärtsilä Finland: superior capacity, cost efficiency, and sustainability

### Company

Wärtsilä is a global leader in innovative technologies and lifecycle solutions for the marine and energy markets. The company emphasise innovation in sustainable technology and services to help their customers continuously improve their environmental and economic performance.

### Challenges & Solution

Wärtsilä Finland tested the LUMI supercomputer for their Computation Fluid Dynamics simulations. The company has very complex and computationally demanding problems that often include mesh motion, chemical reactions, moving particles, and multi-phase flows. Wärtsilä strives for improvements in cost effectiveness and efficiency in demanding simulations. The scope and complexity of the simulations must fit within the required timeframes.



### Benefits

- ✓ Improved efficiency
- ✓ Accelerated R&D processes
- ✓ Reduced energy consumption
- ✓ Reduced costs

### Full story:



**“ We were really positively surprised by the results. The improved efficiency was clearly visible in our test runs. We were able to run our simulations much faster, meeting tight project deadlines and accelerating our R&D processes.”** Bulut Tekgül, Combustion & CFD Expert, Wärtsilä.

## QMill develops quantum algorithms for the future on the LUMI supercomputer

### Company

QMill develops quantum-advantage algorithms which will be executed on near-term quantum computers to solve complex problems that are too large for existing supercomputers.

### Challenges & Solution

The challenge is to find completely new, viable algorithms for future quantum machines and thus reduce the time to beneficial the use of quantum computing. The algorithm development targets industrial optimization customers from different industries and development aims for optimization, cost savings and efficiency, but also for environmental friendliness and energy savings.



### Benefits

- ✓ Quantum technology and algorithms benchmark with HPC
- ✓ Reduced energy consumption
- ✓ Smooth simulations

### Full story:



**“With the LUMI-supercomputer, we are testing whether our quantum circuits work correctly and efficiently and how they scale as we increase the number of qubits. We also use LUMI to benchmark quantum algorithms, i.e. to see how well a problem is solved by classical algorithms on a supercomputer and compare the results with a quantum algorithm,” Ville Kotovirta says.**

## Harnessing AI to reduce emissions: Supersight's vision for the future of real estate

### Company

Supersight Oy is a leading developer of privacy-preserving computer vision technology. The Finland-based company is committed to develop cutting-edge technology that provides people flow analytics as a service for real estate occupancy optimisation. The technology brings efficiency to real estate management, and helps provide for a more sustainable future.

### Challenges & Solution

Processing large-scale visual datasets combined with the development of a sophisticated AI model requires parallel computing to accelerate the training of the necessary neural networks.

The solution was apply for computing resources and access the LUMI supercomputer along with expert support in using the AI model development software.

The LUMI supercomputer was used to accelerate the testing and modification of AI models.



### Benefits

- ✓ Breakthrough technology innovation resulting in a real time privacy protected people flow analysis tool
- ✓ Accelerated R&D processes in 99% accurate AI model development
- ✓ Reduced energy related emissions in real estate business
- ✓ Reduced real estate costs

**“Using LUMI Supercomputer significantly accelerated the testing and modification of our model. This was absolutely crucial in our quest for 99% accuracy in modelling real space usage. With LUMI, we were able to run multiple training processes simultaneously, which ensured that our final model was optimised for performance and scaled well to a variety of environments.”** CEO of Supersight Kimmo Pentikäinen says.

Full story:



## Top Data Science received an exciting opportunity to use the LUMI supercomputer

### Company

Top Data Science specializes in artificial intelligence, machine learning, and software engineering services. The majority of its customers are in the Nordic countries, Germany, and Japan. The biggest solution segment is based on computer vision technologies, which utilize video and other image data to collect information relevant to the customer use case in focus.

### Challenges & Solution

Testing of the EuroHPC LUMI system in R&D Human pose estimation analysis, processing hundreds of video clips in parallel to create a dataset of human skeleton trajectories.

The solution leveraged LUMI's capability to run parallel jobs on GPUs, which combined with the flexible containerization approach offered the needed scalability. Additionally, the comprehensive documentation, with plenty of examples and easy navigation, allowed them to find the necessary information without extra support.

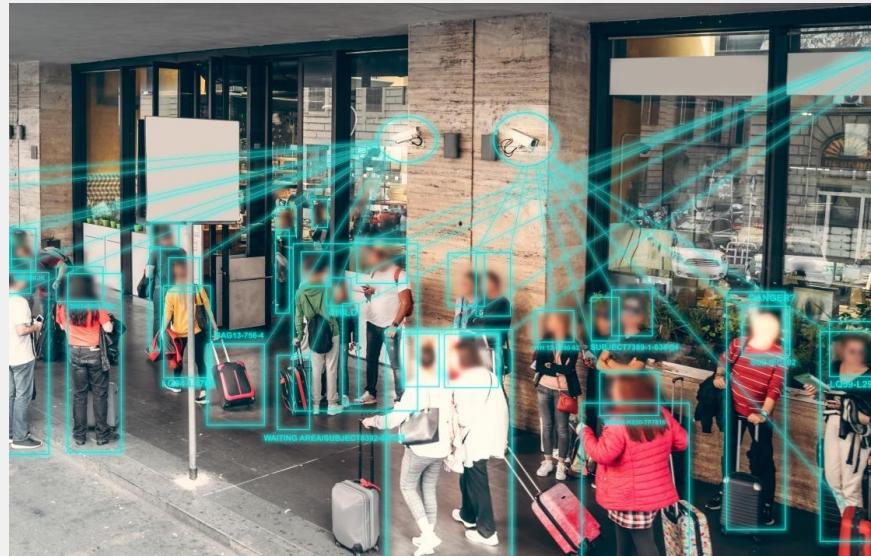

### Benefits

- ✓ Scalability
- ✓ Great documentation
- ✓ Good functionality and ease of use
- ✓ Outsource computationally heavy tasks
- ✓ Generation of the desired human skeleton trajectory dataset

**Full story:**



**“I was pleasantly surprised by how smoothly everything went. The documentation was a great resource; LUMI exceeded my expectations in terms of functionality and ease of use. We were able to effectively outsource computationally heavy tasks and generate the desired human skeleton trajectory dataset, which is now actively utilized in our work”** says Kseniia Khakalo Lead Data Scientist, Top Data Science.

# Sweco Finland uses the LUMI supercomputer for demanding built-environment simulations

## Company

Sweco is Europe’s leading engineering and architecture consultancy company for the built environment and industry. Sweco uses computational fluid dynamics and simulations to develop the built environment and industrial processes with the help of high-performance computing (HPC).

## Challenges & Solution

Realistic and accurate models and simulations require a lot of computing capacity. Cloud computing services have their limitations – the available runtimes may be too short for the modelling needs or the use may become expensive.

Sweco Finland uses LUMI supercomputer to solve the demanding computational fluid dynamic problems of its customers. LUMI offers a cost-effective, flexible and data-secure computing environment to meet the need.

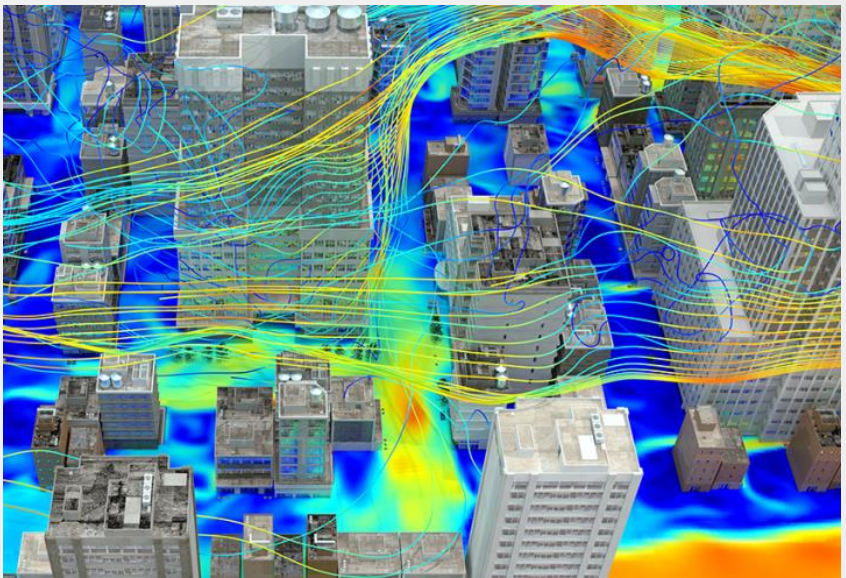

## Benefits

- ✓ Benefits of modern technologies
- ✓ Best possible tools for solving our clients’ challenges that require very specific expertise.
- ✓ Added value in design quality and schedules
- ✓ Cost-efficiency

Full story:



**“LUMI plays a significant part in our toolkit as we wish to offer the benefits of modern technologies and the best possible tools for solving our clients’ challenges”, says Eero Kokkonen, Sweco Finland.**

## Raute develops the future of engineered wood products with the LUMI supercomputer

### Company

Raute Oyj is a global group that develops and supplies technology and services to the wood industry. Raute is the market leader in plywood and veneer beam manufacturing technology and the only company in the world able to offer customers a complete factory-level solution. Raute combines technology, analytics and services to ensure more efficient, predictable and profitable production for its customers.

### Challenges & Solution

The production data collected by Raute, physical wood samples, were at risk of contamination, which would have corrupted the data. Raute had to act quickly to get the necessary results analyzed in time. One calculation round on the LUMI Supercomputer was performed ten times faster than the method normally used by Pesonen's team.

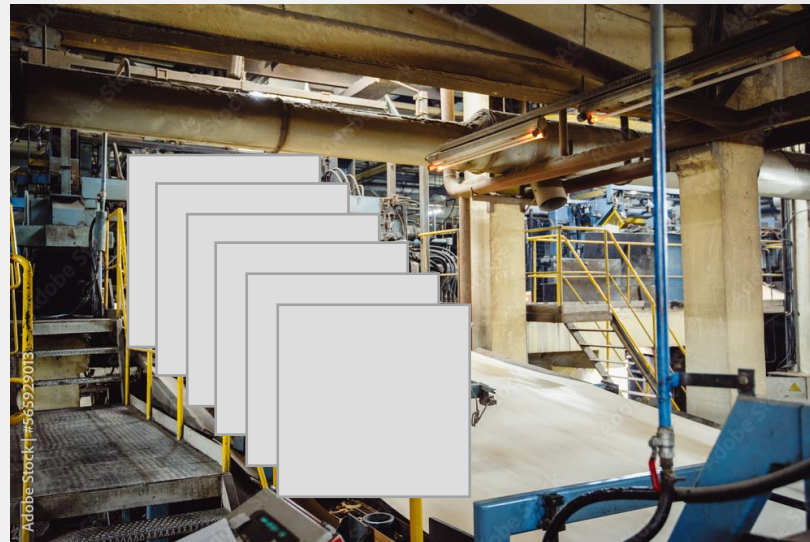

### Benefits

- ✓ 10 times faster calculation
- ✓ Ecological values and the fact that LUMI uses certified, 100% renewable energy
- ✓ The energy consumption when training and using AI models

**"Raute's mission is to help its customers optimize and develop their entire production. This means that we will continue to process huge amounts of data. So far we have mainly used CPU capacity, but we are also exploring the possibility of using GPU capacity," says Pesonen.**

Full story:



## Improving the efficiency of healthcare client encounters with LUMI supercomputer

### Company

Gosta Labs is a Finnish health technology company developing machine learning models to improve patient care and medical practice. The company's flagship product is Gosta Aide, an artificial intelligence assistant with language models tailored to the needs of the social and healthcare sector, automating the creation of client and patient records.

### Challenges & Solution

For health and social care professionals, up to half of their daily working time can be spent on administrative tasks. To solve this problem, Gosta Labs started developing an AI assistant that could help with administrative tasks in healthcare.

First, they set out to solve the problem of generating client and patient records in European languages. Training task-specific machine learning models requires substantial computing power. The LUMI supercomputer was chosen as the best platform for Gosta Labs to train its models.



### Benefits

- ✓ Created several task specific models allowing replacement of large closed models.
- ✓ Improvement of models' performance and resource efficiency
- ✓ Environment independent and improved data protection
- ✓ Improved Scalability to train models for European languages

**“Our project got off to a fast start, and it exceeded our expectations in many ways. During the project, we created several task-specific models that allow us to replace large, closed models. We improved our models' performance and resource efficiency, while also offering an environment-independent alternative to closed large language models from a data protection perspective. Additionally, we achieved the scalability needed to produce the necessary European data sets for training and to train our models for multiple European languages.” Henri Viertolahti, CPO and founding member of Gosta Labs.**

### Full story:



<https://csc.fi/en/story/improving-the-efficiency-of-healthcare-client-encounters-with-lumi-supercomputer/>

## Posiva models the long-term safety of the disposal site for spent nuclear fuel using the LUMI supercomputer

### Company

Posiva Oy is the world's leading final disposer of spent nuclear fuel and is responsible for geological final disposal in Finland. Posiva's final disposal solution is the result of decades of multidisciplinary development work, part of which involves underground facilities at ONKALO® in the bedrock of Olkiluoto.

### Challenges & Solution

Posiva models the evolution of groundwater chemistry in the bedrock for at least 100,000 years as part of ensuring the long-term safety of final disposal. The time span of the final long-term safety assessment is up to one million years. Posiva uses the open source PFLOTRAN modeling program (control volume-based code), developed in the United States, to model groundwater in bedrock. No one has ever done such extensive modelling before, so the challenges are recognized.

LUMI supercomputer enables the combination of different sub-models into a single model. The model is extremely complex: there are many variables, the volume of the area under investigation, Olkiluoto island, is large (approximately 70 km<sup>3</sup>), and the modelling period is about 120,000 years.



### Benefits

- ✓ LUMI's enormous computing capacity and the support available.
- ✓ Supercomputer enables the combination of different sub-models into a single model
- ✓ Sustainability of LUMI support Posiva's carbon-free energy strategy

**“LUMI's enormous computing capacity has been extremely useful to us. We know that it is still more efficient than other supercomputers we have used – among the top 10 of the most powerful supercomputers of the world. Posiva Solutions promotes and sells its expertise and modeling skills internationally. LUMI has opened new opportunities for this, and increased interest in the company among HPC and nuclear waste management communities (interested parties/stakeholders).”** *Tiina Lamminmäki, Principal Chemist, Posiva*

Full story:



<https://csc.fi/en/story/posiva-utilizes-lumi-supercomputer/>

## LUMI supercomputer powers the optimisation of IQM's quantum processors

### Company

Finnish-based IQM is a global leader in superconducting quantum computers. IQM provides both on-premises full-stack quantum computers and a cloud platform for accessing its computers. Customers include leading high-performance computing centres, research labs, universities, and enterprises, which have full access to IQM's software and hardware. IQM has over 300 employees with headquarters in Finland and a global presence in nine countries.

### Challenges & Solution

Simulation of quantum processing units (QPUs) presents new challenges for finite element simulations due to complex geometries and exotic material models.

CSC has been an active developer of Elmer software based on finite element method. The use of Elmer software led IQM to computing collaboration with CSC and using LUMI supercomputer. Elmer finite element software has been used to model and optimise QPU processors. IQM used the LUMI supercomputer to solve electromagnetic simulations in their R&D efforts.

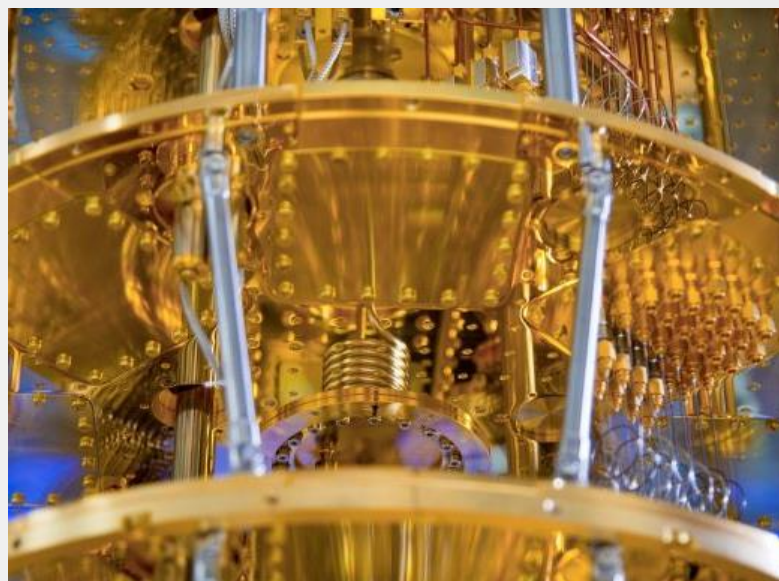

### Benefits

- ✓ Vast computing resources that wouldn't otherwise be available to optimisation of quantum processors
- ✓ LUMI helps accelerate progress in quantum computing.
- ✓ Partnership with CSC in addressing R&D needs within quantum and Elmer solutions.
- ✓ Collaboration in the OpenSuperQPlus project has been beneficial and strengthened IQM's expertise in European quantum development
- ✓ IQM's use of LUMI also has the potential to contribute to societal benefits in the long run. More efficient and powerful quantum computing solutions can accelerate.

**"We have been able to run complex classical electro-magnetic simulations using Elmer to optimize our QPU components in LUMI, which has led to significant improvements in our product development." Juha Hassel, VP of Quantum Technologies at IQM.**

### Full story:



<https://csc.fi/en/story/lumi-powers-the-optimisation-of-iqms-quantum-processors/>

## The quest for leadership in LLM reliability evaluation and quality control with LUMI supercomputer

### Company

The Finnish company Root Signals (now Scorable), based in Helsinki and in Palo Alto, USA, is a leader in automated quality control of AI applications, chatbots and agents that are powered by large language models (LLM). It provides companies with versatile tools to measure and improve the reliability and efficiency of LLM applications.

### Challenges & Solution

LLM evaluation and comparison have been extremely hard problems since the start of the LLM boom. You need a specific LLM to evaluate its reliability. Need of huge computing capacity to train LLM. Trained LLM to judge other LLMs. Root Judge, is specifically finetuned to judge the reliability of another LLM, i.e. to detect hallucinations and to provide transparent justifications for scoring. This helps end-users and developers to evaluate and optimize their LLMs, ultimately building trust in AI-driven evaluation.

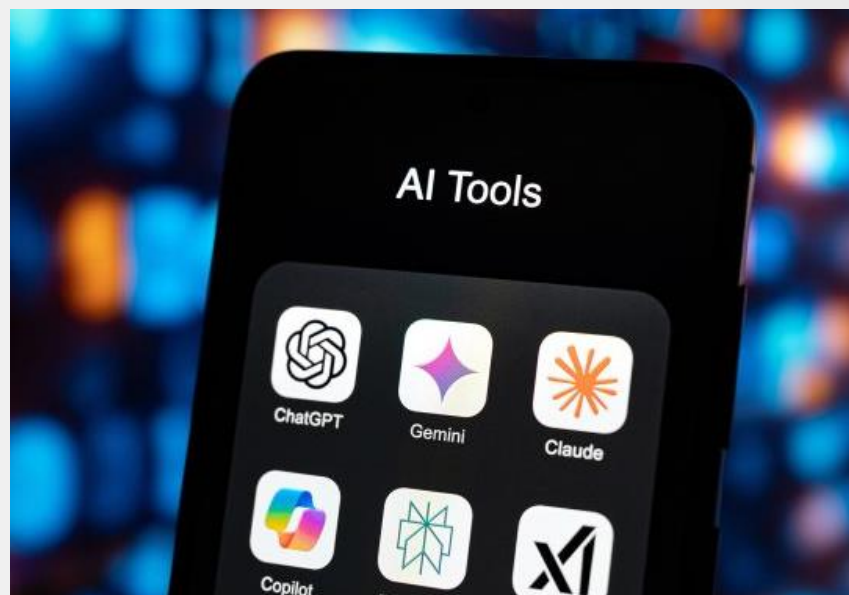

### Benefits

- ✓ LUMI supercomputer was the perfect choice for RDI work. Root Judge is now fast, easy to use and affordable.
- ✓ Root Signals' market position for LLM assessment tools has been strengthened.
- ✓ Root Signals saves costs compared to tools from large players.

### Full story:



<https://csc.fi/en/story/root-signals-the-quest-for-leadership-in-llm-reliability-evaluation-and-quality-control-with-lumi-supercomputer/>

## AI-TRANSPWOOD: AI methods and modelling accelerate the development and use of new, safe, and ecologically sustainable wood-based materials in industry

### Project

The [AI-TRANSPWOOD EU project](#) focuses on transparent wood-based materials and their modelling. The project aims to effectively integrate advanced AI-based computational models with SSbD (Safe and Sustainable by Design) principles for the safe and sustainable design of wood-based composites. The role of VTT and Aalto University in the project focuses on the development of AI-based surrogate models, i.e., lighter AI models that replace the original model, as well as the broad development of various machine learning methods.

### Challenges & Solution

The AI-TRANSPWOOD project utilises the GPU units on the LUMI supercomputer to develop surrogate and physics-driven AI models. They are trained using neural network models and PyTorch software to recognize various wood properties and screen them for the most promising candidates for new materials.



**“Lightweight AI-based surrogate models are used for optimization instead of slow and heavy physics-based models, for example. This significantly speeds up model development.”** Dr. *Marcin Minkowski*, Aalto researcher

### Benefits

- ✓ Development of new AI-based surrogate models, i.e., lighter AI models that replace the original model
- ✓ The most promising surrogate models can be selected for development as AI models, and lighter models can be scaled up massively, for example, in a supercomputer computing environment. This is currently an established method for optimising and discovering new materials.

### Full story:



<https://lumi-supercomputer.eu/ai-transpwood/>

## AB Enzymes Oy use LUMI supercomputer boosting environmentally friendly enzyme development

### Company

**AB Enzymes** is an international biotech business that specialises in developing, producing and supplying industrial enzyme solutions. Its product range stretches from food-grade enzymes to feed and industrial enzyme solutions. AB Enzymes is an established name in the enzyme market, with its eyes fixed on the future through fresh ideas and methods.

### Challenges & Solution

Engineers study the function of proteins, to understand the structure and dynamics of the enzyme and its catalytic reaction, which in turn requires looking at the nanoscale. There are not many methods for doing this. Molecular dynamics simulation, which you could think of as a virtual microscope, is an excellent method for developing experimental results further, to study dynamic phenomena on the nano level. To function, it needs high-performance computing. LUMI Supercomputer combined with Gromacs and PMX make a powerful toolbox for AB Enzymes enzyme modelling and molecular dynamics simulations.



### Benefits

- Part of company's enzyme development toolbox
- Computation as a service has clear cost – cost efficiency
- Clear documentation
- Speed, power and agility in design and product development
- Reduced number of laboratory tests

### Full story:



<https://csc.fi/en/story/lumi-supercomputer-boosting-environmentally-friendly-enzyme-development/>

**“We didn’t buy capacity in LUMI for any particular project – it has become a part of our enzyme development toolbox.”**  
**Joni Vuorio, Senior Research Scientist, AB Enzymes Oy**

## Visidon uses LUMI supercomputer to handle peak workloads

### Company

Visidon develops advanced, optimized software solutions for imaging and video quality enhancement, particularly in embedded electronic systems where computing power is often limited and real-time processing is required. Their technologies leverage AI and machine learning, focusing on visual improvements in image and video quality, better resolution, depth calculation, as well as facial and object recognition and tracking.

### Challenges & Solution

Visidon has its own servers for development work, but sometimes its computing capacity is insufficient. Servers are extremely expensive, and it doesn't make sense to purchase them just for occasional capacity needs, leaving them idle most of the year.

LUMI enables parallel training on multiple GPUs, significantly speeding up processes. Training a single model can be 2–4 times faster than on the company's own servers, and parallelization adds even more power.



**"We use LUMI to finalize our products when our own servers are overloaded. We do research and training mainly on our own servers because that's iterative work. Then, when the research is done and the product needs to be finalized and completed, we switch to LUMI." Mika Helistekangas, IT Systems Manager, Visidon**

### Benefits

- ✓ Speed up processes, 2-4 times faster model tracking compared to company's own servers
- ✓ Computing capacity to handle peak workloads
- ✓ Clear documentation
- ✓ Enables flexible customer service

### Full story:



<https://csc.fi/en/story/visidon-uses-lumi-supercomputer-to-handle-peak-workloads/>

## Visidon uses LUMI supercomputer to handle peak workloads

### Company

Visidon develops advanced, optimized software solutions for imaging and video quality enhancement, particularly in embedded electronic systems where computing power is often limited and real-time processing is required. Their technologies leverage AI and machine learning, focusing on visual improvements in image and video quality, better resolution, depth calculation, as well as facial and object recognition and tracking.

### Challenges & Solution

Visidon has its own servers for development work, but sometimes its computing capacity is insufficient. Servers are extremely expensive, and it doesn't make sense to purchase them just for occasional capacity needs, leaving them idle most of the year.

LUMI enables parallel training on multiple GPUs, significantly speeding up processes. Training a single model can be 2–4 times faster than on the company's own servers, and parallelization adds even more power.



**"We use LUMI to finalize our products when our own servers are overloaded. We do research and training mainly on our own servers because that's iterative work. Then, when the research is done and the product needs to be finalized and completed, we switch to LUMI." *Mika Helistekangas, IT Systems Manager, Visidon***

### Benefits

- ✓ Speed up processes, 2-4 times faster model tracking compared to company's own servers
- ✓ Computing capacity to handle peak workloads
- ✓ Clear documentation
- ✓ Enables flexible customer service

### Full story:



<https://csc.fi/en/story/visidon-uses-lumi-supercomputer-to-handle-peak-workloads/>

## Artificial intelligence solutions for the mining industry through collaboration

### Company

Metso is a frontrunner in sustainable technologies, end-to-end solutions and services for the aggregates, minerals processing and metals refining industries globally. The AIMODE project was initiated by Metso, and the research partners include the Finnish Center for Artificial Intelligence (FAI), VTT, Aalto University, Metso's data visualization system supplier LightningChart, and data analytics company Quva.

### Challenges & Solution

Optimizing and visualizing the mining process requires combining physics and data-driven approaches.

The three-year [AIMODE collaboration project](#), funded by Business Finland and starting in 2022, aims to optimize mining industry processes and their real-time monitoring using artificial intelligence, as well as to develop an AI-assisted control system based on industrial data. Mathematical optimization problems, process models, and control systems require efficient calculating.

Use of the resources of the project members or CSC, depending on the scaling needs: desktop computers, local clusters, commercial cloud services, and even CSC's high-performance computing services.



### Benefits

- ✓ Computing programs and machines according to each project and computing need
- ✓ The use of the Geminex digital twin simulation environment used by Metso
- ✓ Collaborative projects benefit everyone involved: valuable references, new projects, new contacts, and new expertise
- ✓ Industry knowledge

### Full story:



**"Computing programs and machines are used according to each project and computing need. It is important to the customer that we manage the systems that suit their computing needs cost-effectively on their behalf. We utilize the resources of the project members or CSC, depending on the scaling needs." Joonas Linnosmaa, VTT**

<https://csc.fi/en/story/artificial-intelligence-solutions-for-the-mining-industry-through-research-collaboration/>

France

## Data science & Machine Learning Development of prediction and investment rules

### Company

Since its creation in 2011 in Paris, Advestis part of Mazars offers services of applied research in data science and put into production some machine learning systems.

### Challenges & Solution

Advestis has developed an artificial intelligence algorithm capable of generating interpretable investment rules, based on data from financial results. Even filtered, the number of generated rules remains significant and the restitution time of the algorithm was too high.

Criann’s HPC engineer accompanied the R&D team of Advestis in the optimization and execution of the algorithm, coded in Python, and using the package mpi4py for parallelization.

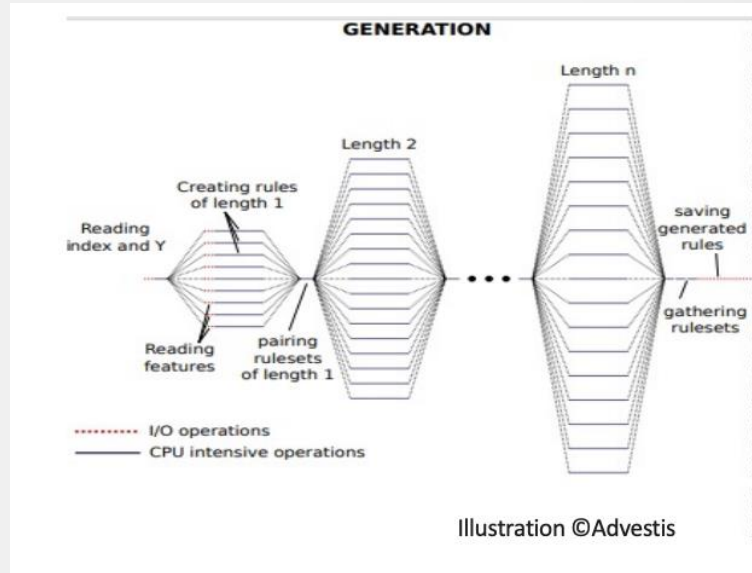

### Benefits

- ✓ Restitution times have been divided by 20, which results in a very clear reduction in the costs of calculation.
- ✓ Improved prediction quality and increased financial performance.

### Full story:

*“The assistance from CRIANN, both for handling the calculation nodes and for advice on optimizing the code, was of very good quality and allowed us to progress very quickly. »*

**Philippe COTTE, LEAD PYTHON ENGINEER, Advestis part of Mazars**



## Independent portfolio management company part of the Ecole Polytechnique incubator nursery

### Company

Created in 2021, Horae Technology offers investment solutions for individuals and institutions.

### Challenges & Solution

Horae Technology is developing an innovative decision support tool combining artificial intelligence and behavioral finance. In September 2021, Horae Technology joined the Euro-CC program, in order to benefit from high-level support in intensive computing.

This computing power has notably enabled the company to accelerate the performance of its tool via the parallelization of its code and the possibility of analyzing thus thousands of financial securities simultaneously.



Retroactive evaluation of buy and sell signals on the CAC 40 index

### Benefits

- ✓ Improve the calculation time of training algorithms
- ✓ Significantly increase the power and robustness of the AI models.

*Individual and personalized support allowed the company to quickly become autonomous in the use of the supercomputer.*

**Full story:**

**CCFR** CENTRE DE COMPÉTENCE HPC.HPDA.IA



## How to provide a statistically significant set of data of extreme weather events

### Company

RiskWeatherTech supports its institutional and private customers in the risk management and the study of the vulnerability of territories and businesses.

### Challenges & Solution

Faced with the recurrence of intense weather disturbances in France, Risk Weather Tech has developed, thanks to Myria supercomputer at Criann, a vast catalog of storms physically and statistically plausible. Main objectives: anticipate potential damage on infrastructure and map more precisely the risks of insurance claims.

Proof of concept :

- Building a database of climate events
- Accurate mapping of claims risks



### Benefits

- ✓ Simulation of 10,000 realistic storms that could occur in France
- ✓ More than 870,000 CPU hours was needed

*The catalogue of 10,000 storms the catalogue is a tool for the insurance industry to analyse the risks associated with storms in France*

**Full story:**

**CCFR** CENTRE DE COMPÉTENCE HPC.HPDA.IA



## Opening of public bathing sites in the natural environment

### Company

The PROLOG INGÉNIERIE group, an independent consultancy engineering firm, in the field of water and associated remotely managed systems, works to improve water quality.

### Challenges & Solution

How to succeed in opening swimming sites in Marne after the Paris 2024 Olympic Games? To support the management plans put in place by public authorities in these highly urbanized areas, Prolog engineering has developed a model coupling hydrodynamics and water quality on the Criann supercomputer.

Proof of concept :

- 3D hydrodynamic simulation of a section of the river Marne with consideration of pollution sources
- Deployment on HPC architecture
- Getting started with the HPC environment

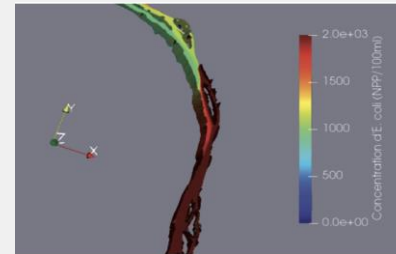

Fine modeling of the dispersion of bacteriological strains from their point of emission

### Benefits

- ✓ Speed of calculation time
- ✓ Fine representation of pollution dispersion
- ✓ More than 120,000 CPU hours was needed

*Numerical simulation and HPC in support to public authorities for management plans*

**Full story:**

**CCFR** CENTRE DE COMPÉTENCE HPC.HPDA.IA



## AI medical device software to quantify brain damage and clinical prognosis

### Company

Braintale is an innovative company dedicated to deciphering the white substance to allow better treatment in neurology and intensive care with prognostic solutions clinically validated.

### Challenges & Solution

Braintale has joined the Euro-CC program, in order to benefit from high-level support in supercomputing

This computing power has notably enabled the company to analyze in efficient conditions the data of more than 500 patients in order to develop its research tools to optimize the intake in charge of brain diseases

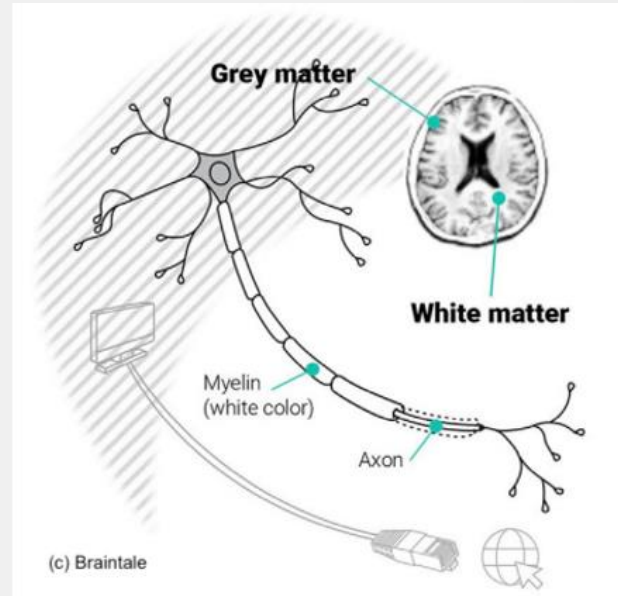

### Benefits

- ✓ Optimization of retrospective analysis of large research cohorts
- ✓ Intensive processing of very large volumes of data

*HPC for the development of an innovative medical device that will benefit to patients, medical professionals and researchers*

**Full story:**

**CCFR** CENTRE DE COMPÉTENCE HPC.HPDA.IA



## Multi-scale and multiphysics simulation of a dam on HPC architecture

### Company

CEVAA, part of the 6NAPSE Group, is an engineering office specialized in acoustics and mechanics, with a range of expertise and testing facilities for Industry.

### Challenges & Solution

CEVAA was requested to study the mechanical performance of a dam. With length scales ranging from centimeter to several tens of meters, consideration of multiphysics loadings (temperature, pressure, efforts), the internal calculation resources of the company were clearly insufficient to conduct the study.

The study was carried out on the Myria supercomputer of CRIANN with Code\_Aster software for calculations and Salome-Meca for meshing and post-processing.

- installing the latest versions sequential and parallel of Code\_Aster
- help with creating scripts launch of calculations.

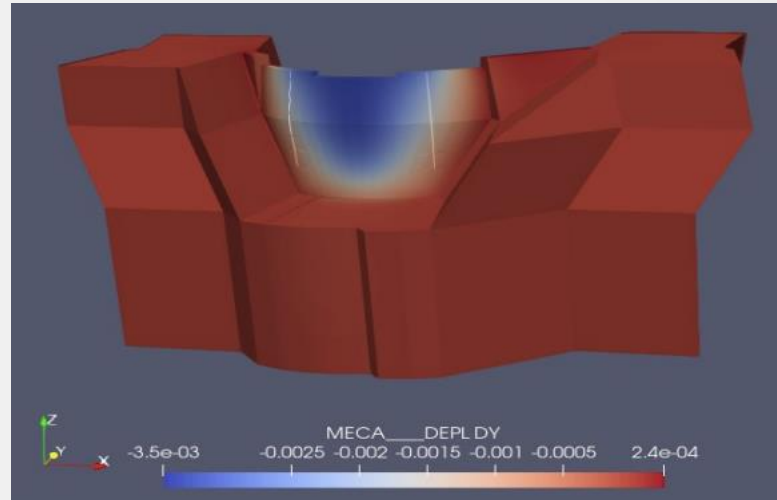

Results of mode shapes on a dam

### Benefits

- ✓ HPC expertise
- ✓ Solve client projects with a significant productivity gain

*For CEVAA project, the support consisted in installing the latest sequential and parallel versions of Code\_Aster, and providing scripts for calculation launches.*

**Full story:**

**CCFR** CENTRE DE COMPÉTENCE HPC.HPDA.IA



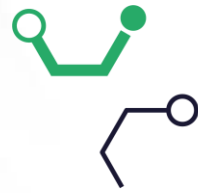

## Development of an on-board battery charger

### Company

Infinergies – Part of Groupe 6Napse is Power electronics design office. Its expertise and capacity for innovation place it at the heart of the development of innovative solutions in various industries.

### Challenges & Solution

Involved in the development of an on-board battery charger for electric vehicles, Infinergies was faced with the problem of the cumulative duration of the simulations to be implemented.

The product must be able to charge the battery, but also supply electricity to the grid, or power electrical outlets in the vehicle, whatever the battery's state of charge.

This requires a large number of simulations to test these numerous operating cases.

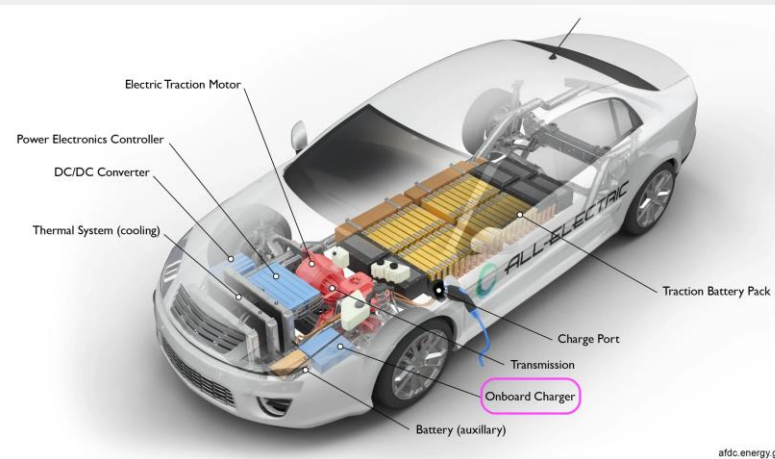

Image source: <https://afdc.energy.gov/vehicles/how-do-all-electric-cars-work>

### Benefits

Simulation of a large number of operating points.

Compliance with the end customer's specifications in a tight timeframe.

*“Our schedule was very tight. The help we received in setting up our simulations on the supercomputer was extremely effective, and then access to the computing power enabled us to solve our industrial problem within the deadline.”*

**Adrien Thurin, COO @Infinergies – Groupe 6NAPSE**

**Full story:**

**CCFR** CENTRE DE COMPÉTENCE HPC.HPDA.IA



## Development of explicit non-linear reference software for space applications.

### Company

Abstrao – this company is specialized in integrating numerical modelling into the analysis and optimization of systems subjected to extreme loading.

### Challenges & Solution

First evaluation of the scalability of a multi-GPU HPC version of the code.

Technological demonstrations through applications linked to hypervelocity impacts of space debris on satellite protective structures.

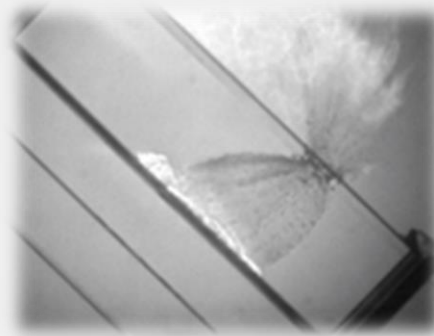

→ Hypervelocity  
impact test result at  
7.2km/s

[https://www.esa.int/ESA\\_Multimedia/Images/2013/04/Hypervelocity\\_Impacts](https://www.esa.int/ESA_Multimedia/Images/2013/04/Hypervelocity_Impacts) EMI test 3915

→ ABSTRAO Solver result

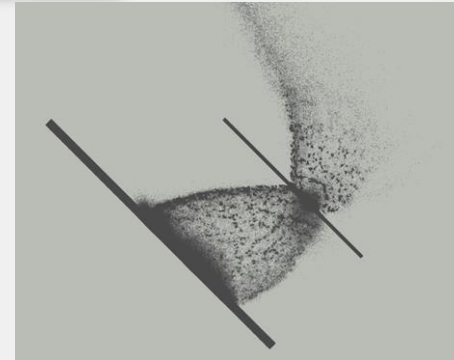

### Benefits

Very good weak and strong scalability (90%) on 30xA100 on *Turpan* - MESONET ARM machine

Significant progress in code maturity

*“The collaboration between CALMIP and ABSTRAO has been decisive in the first evaluation of the ABSTRAO HPC Solver performances. This partnership has leveraged CALMIP's infrastructure and technical expertise, enabling a comprehensive and rigorous assessment of the solver's capabilities.”*

**Jérôme Limido, CEO ABSTRAO**

**Full story:**

**CCFR** CENTRE DE COMPÉTENCE HPC.HPDA.IA



## Virtual reality creation for theme parks / VR headsets

### Company

MackOne is a French company specializing in entertainment, with a strong focus on fully immersive virtual reality experiences designed for theme parks and VR platforms.

### Challenges & Solution

Producing high-quality immersive VR content for theme parks requires intensive 3D rendering and thorough validation before production. MackOne faced the challenge of efficiently handling large-scale rendering workloads to test and validate VR content early in the pipeline. With support from URCA (CC-FR), the company installed a dedicated Blender render farm leveraging GPU resources. This setup allowed parallel execution of rendering tasks, significantly accelerating content generation and enabling iterative testing of virtual environments. The solution reduced production risks, optimized rendering times, and ensured high visual quality before deployment.

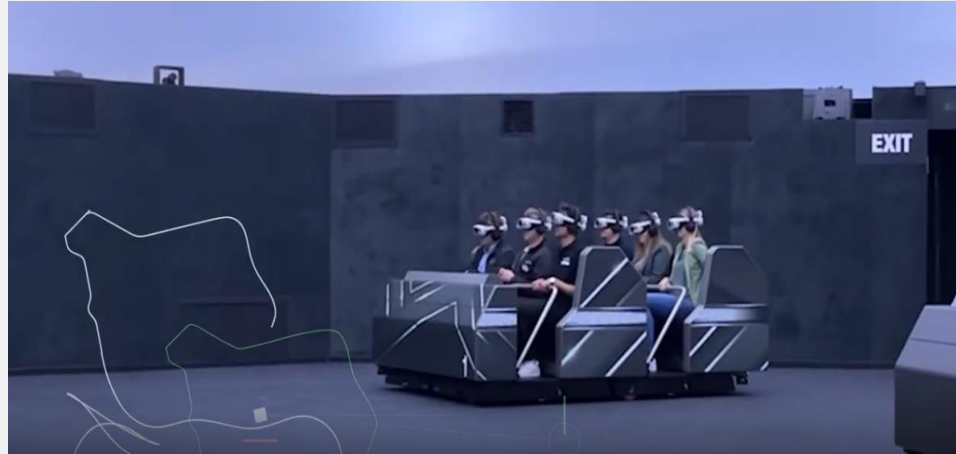

### Benefits

Deployment of a scalable Blender GPU render farm

Acceleration of 3D rendering and VR content validation workflows

Improved production reliability through pre-production testing

Access to 5,000 GPU hours for intensive rendering tasks

Successful delivery of a VR attraction for a major theme park

The render farm solution enabled MackOne to bring the VR attraction into production at Europa-Park for the Halloween 2024 season. By validating content before deployment, the company reduced development timelines and ensured a high-quality immersive experience for end users. This collaboration demonstrates how HPC and GPU resources can support creative industries by accelerating production workflows and enhancing visual performance.

### Full story :



## Development of an AI Model Architecture for EEG-Based Patient Classification

### Company

Bioserenity provides diagnostic solutions in the fields of sleep medicine and neurology. Its offering relies on innovative EEG devices (Icecap) enhanced by artificial intelligence, combined with a network of technicians and physicians enabling remote medical interpretation.

### Challenges & Solution

Training large-scale AI models for EEG analysis is challenging due to the complexity, variability, and high dimensionality of electrophysiological signals. Bioserenity aimed to develop an innovative foundation model to accelerate EEG-based biomarker development and improve patient classification. To achieve this, the company leveraged high-performance GPU resources at the ROMEO computing center, supported by dedicated technical guidance. This setup enabled large-scale experimentation and efficient training of the AI model, allowing performance comparisons with existing deep learning approaches. The solution provided a scalable, reusable architecture for multiple clinical applications in neurology and sleep medicine.

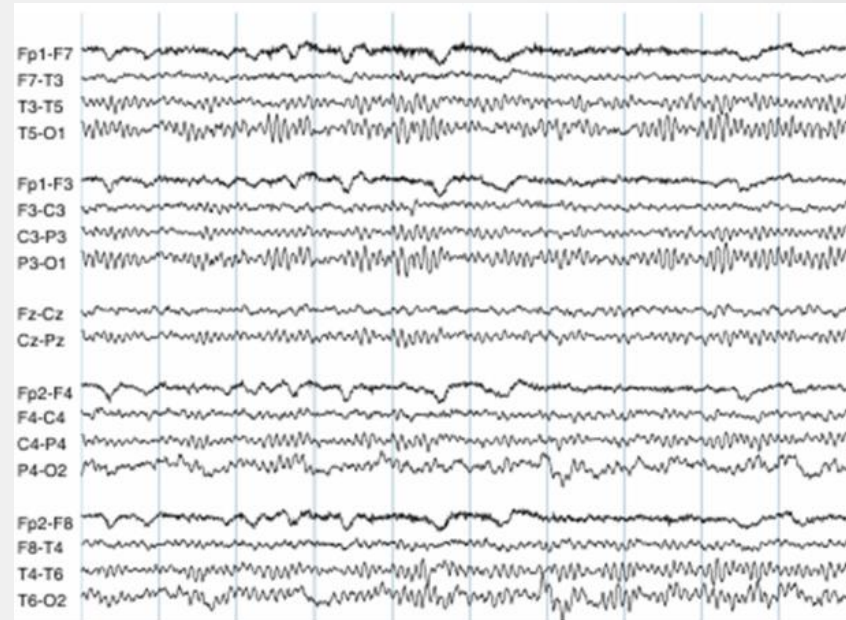

### Benefits

- Successful training and evaluation of a novel EEG foundation model architecture
- Improved classification performance compared to standard deep learning approaches
- Acceleration of EEG biomarker development
- Access to 500 GPU hours enabling large-scale experimentation
- Strengthened AI capabilities for clinical applications in neurology and sleep medicine

Thanks to access to GPU resources at the ROMEO computing center, a new AI architecture could be tested and validated for foundation model construction. The trained model (LBM) demonstrates superior performance compared to conventional deep learning models for classifying pathological patients based on EEG data. These results highlight the potential of foundation models to improve diagnostic accuracy and accelerate biomarker discovery, reinforcing Bioserenity's innovation capacity in AI-driven medical diagnostics.

Full story :



## Development of an air traffic controllers' scheduling optimization application

### Company

The DSNA is responsible for providing air traffic control, voice communication, navigation, and surveillance services, as well as aeronautical information services, to aircraft operating under general air traffic in French airspace.

### Challenges & Solution

Scheduling air traffic controllers is highly complex due to strict legal and social constraints and fluctuating traffic demand. Manual roster creation was error-prone and inefficient. To address this, a dedicated application was developed to automate the process, integrating traffic forecasts and regulatory constraints. The tool generates optimized rosters, reduces manual errors, and ensures compliance. It is currently being tested on site with real operational data, paving the way for more efficient and reliable controller scheduling.



### Benefits

- Automation of air traffic controller scheduling
- Compliance with legal and social constraints
  - Optimization of workforce allocation according to traffic demand
  - Reduction of manual errors in roster creation
  - Enhanced operational efficiency and planning reliability

The solution is expected to improve operational efficiency by ensuring that the right number of controllers are available at the right times, reducing scheduling errors, and allowing better response to traffic demand. It also lays the groundwork for future scaling and integration with other air traffic management systems.

**Full story :**



## Fine-scale air quality forecasting in the Grand Est region using machine learning models

### Company

ATMO Grand Est is the reference expert on air quality in the Grand Est region. As a public interest organization, it brings together all regional stakeholders involved in air monitoring, public communication, and the implementation of actions to improve air quality.

### Challenges & Solution

ATMO Grand Est sought to develop an AI-based forecasting tool capable of simulating hourly pollutant dispersion at high spatial resolution over a test territory. The main challenge was to replace a computationally intensive deterministic model with a faster approach while preserving prediction accuracy. This was achieved by adopting neural network models trained on representative datasets generated from physical simulations. Deployed on a GPU-equipped computing center, the solution evolved from a CNN to a U-NET architecture, integrating multiple emission sources and larger learning domains. These improvements significantly reduced computation time and enabled scalable deployment across the entire Grand Est region.

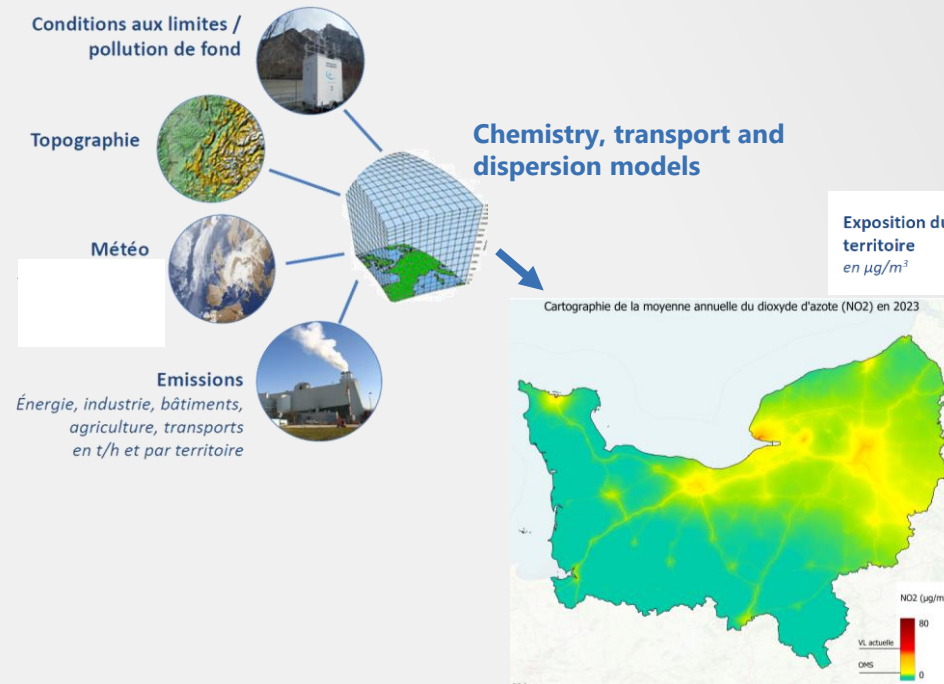

### Benefits

Full forecasting workflow implemented, including a backup chain

Computational time for one zone: 7 hours on 1 CPU (reduced to 30 minutes on 20 CPUs) | Sirane

Computational time with 1 GPU: 5–10 minutes | SiraNET

Significant acceleration of scenario testing while maintaining high prediction accuracy

« Characterising air pollution on a fine scale, i.e. close to the emission sources (road traffic, industry, etc.), is now essential to support the actions to be implemented in order to improve air quality. The information produced by fine-scale modelling is useful to local authorities in assessing public policies to reduce pollutant emissions, and to health authorities in assessing the health impact of air pollution. » (Jérôme Godart, ingénieur, [contact@atmonormandie.fr](mailto:contact@atmonormandie.fr))

### Full story :



## Injection of terminological knowledge and grey literature in health into a generative LLM on multi-GPU infrastructure

### Company

The Digital Health Department (DéSaN) of Rouen University Hospital is a multidisciplinary team in medical informatics and medical documentation. DéSaN develops and maintains three major health knowledge sources: CISMéF (Catalogue and Index of French-Language Medical Sites - over 130,000 full-text resources), LiSSa (Scientific Literature in Health - 1.2 million metadata entries), and HeTOP (Health Terminology/Ontology Portal - 109 health terminologies and ontologies in 55 languages).

### Challenges & Solution

Generative Large Language Models (LLMs) lack specialized knowledge in the French medical domain. DéSaN aimed to inject millions of medical concepts from HeTOP, CISMéF, and LiSSa databases while preserving the model's generative capabilities. With support from CRIANN, a multi-GPU environment on the Austral supercomputer enabled two approaches: Continual Pre-training (CLM) and LoRA fine-tuning. Both methods successfully infused medical knowledge, with LoRA proving faster and more scalable. This solution enhanced the LLM's domain expertise while maintaining its general-purpose abilities, enabling more accurate and reliable medical language generation.

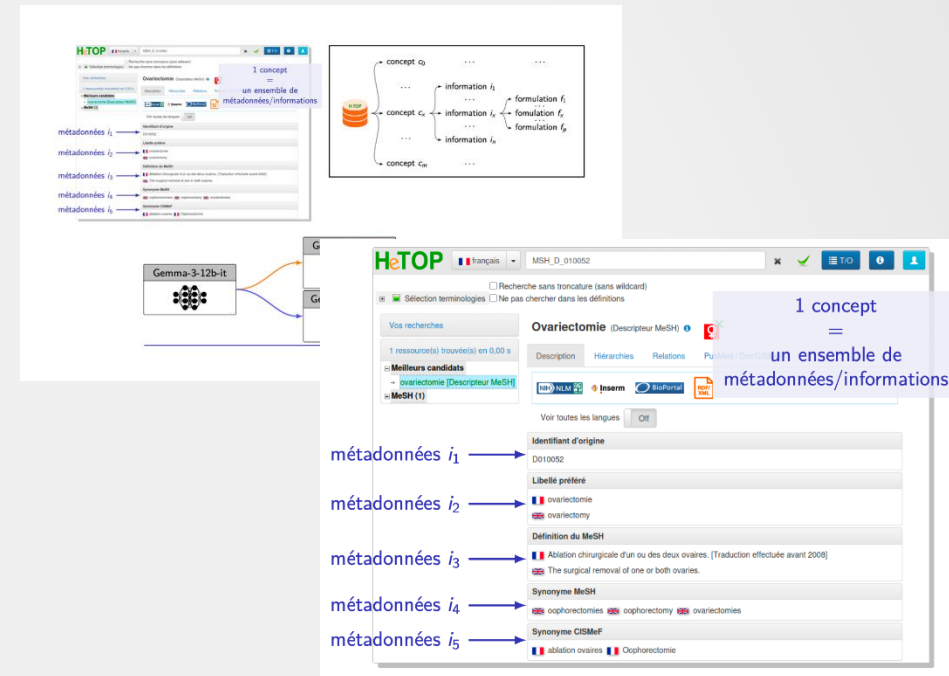

### Benefits

Effective injection of millions of medical concepts into a generative LLM

Preservation of the model's general-purpose capabilities while specializing in medical knowledge

Efficient training using LoRA: 2 hours with only 110 GB memory, compared to 20 hours and 406 GB for CLM

Scalable approach suitable for large medical corpora

Contribution to AI-assisted medical research and future hybrid LLM developments

### Full story :



The project successfully enriched the LLM with French medical knowledge, enabling it to accurately retrieve domain-specific information previously unknown to the base model. LoRA fine-tuning demonstrated a realistic and scalable approach for large datasets, maintaining the model's general-purpose functionality while specializing in medical tasks. This work enhances the potential of AI-assisted medical applications and provides a framework for future research, including hybrid methods such as Retrieval-Augmented Generation (RAG) and integration with symbolic AI and ontological data. The results were presented at JCAD 2025 in Lille on September 17, 2025, promoting scientific dissemination and collaboration.

## Parallelization and optimization of space thermal simulations for digital twin

### Company

Dorea Technology is a small company founded in 2006, based in Sophia Antipolis, specialized in thermal and mechanical simulation software development for the space sector. The company works with prestigious partners (Thales Alenia Space, ESA, CNES) and is a member of the Network of Experts for Space Thermal Analysis (NESTA).

### Challenges & Solution

In-flight thermal correlation of satellite models involves optimizing numerous uncertain parameters, but each iteration requires simulating a full orbit, leading to prohibitive computation times. Dorea aimed to accelerate these correlations as part of an ESA satellite thermal digital twin project. With support from CRIANN, evaluations were parallelized across multiple CPU cores on the Austral supercomputer using Python and the GEMSEO library. This approach drastically reduced convergence times while enabling efficient exploration of the high-dimensional parameter space. The solution provided faster, more reliable thermal model correlations, supporting precise satellite design and analysis.



### Benefits

Parallelized evolutionary optimization for high-dimensional satellite thermal problems

Threefold performance improvement using 48 CPU cores on the Austral supercomputer

Efficient exploration of large parameter spaces and reduced convergence times

Enables quantitative sensitivity assessment and high-quality orbital correlation

Supports ESA satellite thermal digital twin research with HPC-driven acceleration

Initial tests achieved a threefold performance gain using 48 CPU cores compared to 20 cores on a standard desktop machine. This acceleration enables efficient distribution of orbital simulations required by evolutionary optimization algorithms, significantly reducing convergence times and allowing quantitative sensitivity assessments of solutions. As a result, the project now enables correlation quality that would have been impossible under conventional computational constraints. The work has been submitted to the ICES 2026 conference (International Conference on Environmental Systems) organized by NASA, highlighting its scientific relevance and impact.

Full story :



## Development of an Automated Staff Scheduling Application for a Nursing Home

### Company

The Renaissance group operates several residential care facilities for elderly people. It focuses on improving the quality of care and working conditions through organizational innovation and digital tools in the medico-social sector.

### Challenges & Solution

Nursing homes face complex scheduling challenges due to temporal, human, and logistical constraints, while aiming to improve staff conditions and resident satisfaction. The project sought to automate staff planning using advanced optimization techniques tailored to medico-social facilities. Leveraging Google's OR-Tools, a hybrid approach combined constraint programming (CP-SAT) to maximize resident satisfaction with a Vehicle Routing Problem (VRP) model to minimize task duration. This solution balanced quality of service and operational efficiency, ensuring fair workload distribution and timely care. It also demonstrated the broader potential of HPC and AI optimization in the socio-economic sector.



### Benefits

- Automated generation of realistic and constraint-compliant staff schedules
- Improved workload distribution and staff mobilization
- Increased resident satisfaction through respect of preferred time slots
- Hybrid optimization approach balancing service quality and operational efficiency
- Demonstration of AI and combinatorial optimization relevance in the medico-social sector

### Full story :



The initial results demonstrate the feasibility and relevance of the proposed approach. The prototype is capable of automatically generating realistic staff schedules that respect the constraints defined by EHPAD Renaissance. It currently handles personal care tasks using a dedicated model and manages breakfast activities as specific tasks. Visualization tools, including staff and resident timetables, were manually generated to facilitate interpretation and validation of the results. From a technical standpoint, CP-SAT produces high-quality schedules at a high computational cost, while VRP offers fast resolution but requires careful constraint tuning. Their combination opens the way to a robust and production-ready hybrid solution for care planning.

## Post-Fire Structural Assessment of Notre-Dame Cathedral, Paris

### Company

The Geometry–Structure–Architecture (GSA) Laboratory at ENSA Paris-Malaquais focuses on the intersection of engineering sciences and architecture. Since 1990, it has explored innovative structural, geometric, and material approaches, combining theoretical, historical, and experimental research to advance architectural design.

### Challenges & Solution

Standard calculation methods were insufficient for analyzing a 12th-century construction made of stone blocks and mortar joints. Accurate scientific insight was needed to support restoration project management. Researchers developed detailed models and collected on-site measurements, then used high-performance computing to simulate deformations and stresses within the building. The simulations required 25,000 CPU hours on the CRIANN supercomputer, providing precise predictions to guide the restoration work. This approach ensured structural safety and informed decision-making for the preservation of the historic structure.

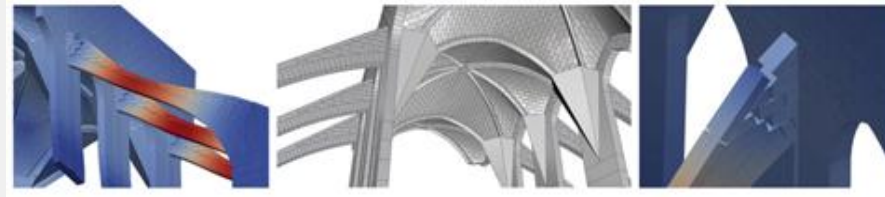

### Benefits

High-fidelity structural modeling of a 12th-century cathedral, including stone blocks, mortar joints, and vaults

Ability to simulate complex deformations and stress distributions with over 1 million finite elements

Realistic representation of openings, cracks, and flying buttresses to guide restoration decisions

Intensive computation validated by 25,000 CPU hours on the CRIANN supercomputer, demonstrating the capacity for large-scale heritage simulations

Integration of site measurements into predictive models, bridging on-site data and numerical simulations

### Full story :



The block-by-block finite element modeling with interfaces, implemented in the CEA's Cast3m software, allows for a highly detailed representation of the cathedral's structure. By meshing even a quarter of a vault with over a million elements, the simulations provide precise insights into the building's behavior, despite requiring six days of computation. The model realistically captures openings and observable cracks in the flying buttresses and the choir, offering valuable information for restoration and structural analysis.

## Development of educational material for quantum computing teaching

### Company

The Department of Mathematical Engineering at INSA Rouen Normandie trains generalist engineers in applied mathematics and computer science. The department graduates approximately 60 engineers per year and is affiliated with the Laboratory of Mathematics (LMI, UR 3226), member of the CNRS Normandie Mathematics Research Federation.

### Challenges & Solution

Quantum computing offers promising applications in combinatorial optimization, but hands-on experimentation remains challenging for students. The project aimed to create a practical work module for Master 2 students to explore Quantum Annealing algorithms using Nvidia GPUs on HPC infrastructure. CRIANN provided access to GPU resources and supported the setup of quantum emulation environments. Educational materials were developed in collaboration with INSA Rouen Normandie, culminating in a dedicated conference that combined theory and practical demonstrations. This approach bridged the gap between quantum computing concepts and real-world experimentation in a high-performance computing setting.

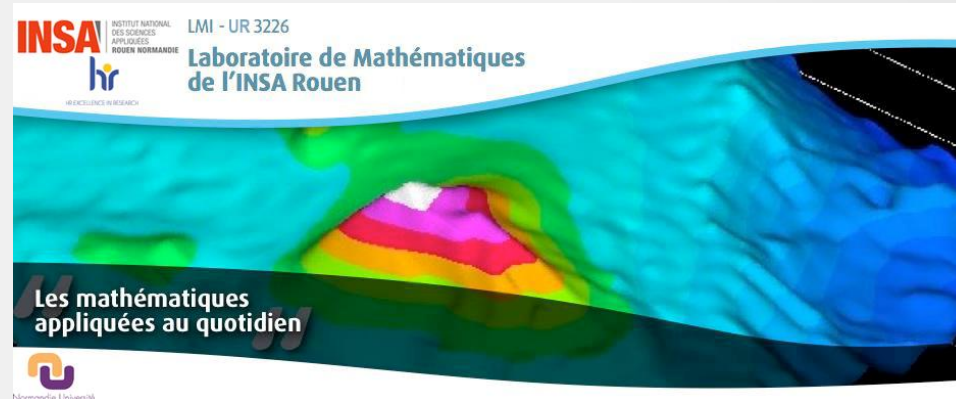

### Benefits

Practical experience for students in quantum emulation and Quantum Annealing algorithms

Integration of HPC infrastructure (Nvidia GPUs) into higher education teaching modules

Enhanced curriculum with cutting-edge quantum computing applications

Strengthened collaboration between academia and HPC facilities for educational innovation

Foundation for future projects leveraging HPC for quantum computing education

The project successfully integrated quantum computing concepts into INSA Rouen Normandie's mathematical engineering curriculum. By leveraging HPC resources for practical experimentation, students gained hands-on experience with Quantum Annealing algorithms on realistic combinatorial optimization problems. This initiative not only enhanced the quality of education but also demonstrated the feasibility of using HPC infrastructure for advanced quantum emulation in higher education. The collaboration with CRIANN created a framework for future educational developments and innovative courses combining quantum computing and high-performance computing.

### Full story :



## Development of a parallel partitioning algorithm for the Dorothy code

### Company

LOMC (UMR CNRS 6294) is a joint research unit associated with Le Havre Normandie University and CNRS. The laboratory specializes in the study of mechanical wave propagation, the behavior of complex media, as well as applications in port and coastal engineering, geo-environment, and non-destructive structural testing. LOMC notably develops Dorothy, a numerical simulation software for computational fluid dynamics (CFD) based on the Vortex Particle Method (VPM), developed jointly with IFREMER. This code, written in Fortran 90 and parallelized with MPI, discretizes the fluid into vorticity-carrying particles.

### Challenges & Solution

The Dorothy code faced a major scalability bottleneck due to its particle redistribution algorithm, which required gathering all particles on each process, causing memory spikes and limiting large-scale simulations. LOMC aimed to redesign the algorithm to maintain load balancing and numerical accuracy while enabling scalability. With CRIANN's support, a fully parallel redistribution method was developed, using a two-stage process with local partitioning and MPI AllToAll exchanges. Implemented in Python and integrated into the Fortran 90 code, the solution successfully scaled simulations of 5 million particles across 192 cores, drastically improving efficiency and enabling large-scale studies.

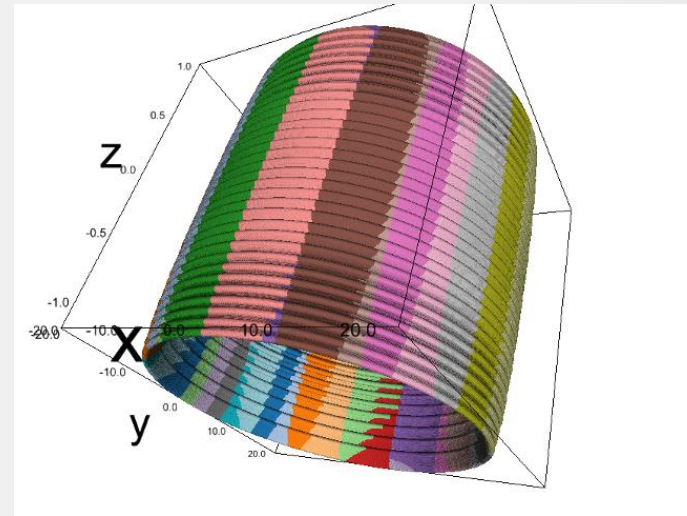

### Benefits

**Fully parallel particle redistribution eliminating memory bottlenecks**

**Efficient load balancing and high numerical accuracy maintained**

**Enables large-scale simulations of millions of particles**

**Extremely low redistribution times (<5 ms) on up to 192 cores**

**Integration into Dorothy code facilitates advanced CFD research and complex simulations**

The fully parallel redistribution algorithm removes the previous memory limitation, allowing the Dorothy code to handle much larger particle simulations. Redistribution times remain extremely low (less than 5 ms) even on 192 cores, while partitioning computation scales efficiently. Integration of the algorithm into the Dorothy code during the Extreme CFD Workshop 2025 enables LOMC to perform larger and more complex computational fluid dynamics simulations. This improvement strengthens the laboratory's capacity to tackle advanced CFD problems and accelerates research outputs in fluid dynamics modeling.

**Full story :**



## Numerical modeling and creation of AI models based on information from nuclear measurement devices

### Company

SMARTIUM is a data processing expert for applications in physical measurement. The company combines Artificial Intelligence (AI), numerical modeling, and Monte Carlo simulation to provide custom, reliable, precise, and flexible software solutions.

### Challenges & Solution

SMARTIUM faced the challenge of accelerating complex nuclear physics simulations while simultaneously training AI models on large-scale datasets to improve their radioactivity measurement systems. The computational demand of combining Monte Carlo simulations with deep learning exceeded their local resources, making timely predictions difficult. To address this, SMARTIUM leveraged high-performance computing resources at the ROMEO center, using CPU clusters for numerical simulations and GPU machines for AI model training. This combination enabled faster processing without compromising accuracy. Technical support ensured efficient use of the infrastructure, allowing SMARTIUM to optimize both simulation and predictive modeling workflows. As a result, the company achieved more precise predictions, reduced computational times, and enhanced the overall performance and reliability of their measurement systems.

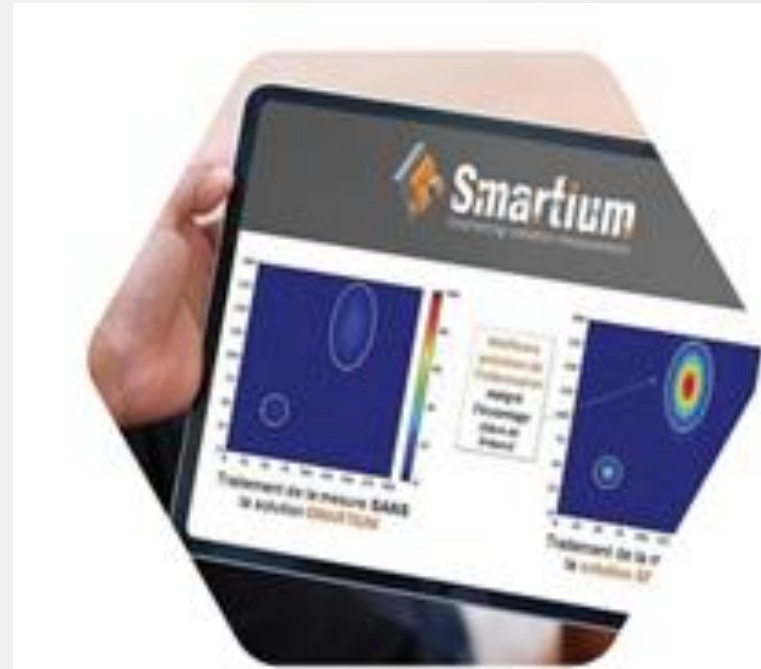

### Benefits

- 1,500 GPU hours used for training and simulation,
- Significant acceleration of computations and analyses,
- Increased accuracy of predictive models.

### Full story :



Thanks to this solution, SMARTIUM achieved more accurate predictions and simulations for their measurement systems. The performance and reliability of their radioactivity measurement processes improved significantly, enabling faster and more precise analyses. This led to better-informed decisions and strengthened confidence in the company's nuclear measurement solutions.

Hungary



## Tengr.ai revolutionizes the creative industry using Komondor

### Company

Tengrai Artificial Intelligence kft. was founded in 2023 with the goal of creating a European image-generation startup. It has already released a free-to-use image generation to the public, while video- and web generation is in the proof-of-concept stage.

### Challenges & Solution

The biggest challenge was to create a solution that creates images at least as good as the American competitors while following the privacy-by-design philosophy that does not have gender or racial bias. It needs to easily "forget" styles if there are copyright claims for parts of the training dataset. Moreover, the founders were living during communist regimes, so they are against censorship while also forbidding illegal content generation.

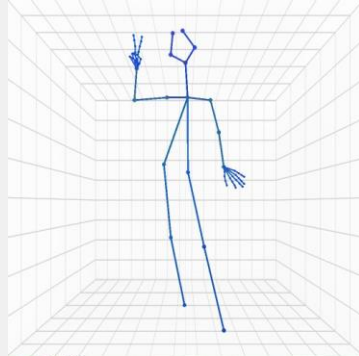

### Benefits

- ✓ Enable everyone to express their creative freedom
- ✓ Replace overused and boring stock photos
- ✓ Easy-to-use and accessible image generation
- ✓ Multilingual and multicultural, without racial or gender bias
- ✓ Video and website generation

*"KIFÜ enabled this project through Komondor HPC; without their help and support, the Tengr.ai project would not stand a chance in this highly competitive and fast-paced environment."*

**Peter W. Szabo, Founder and researcher @Tengrai Artificial Intelligence kft.**

### Full story:

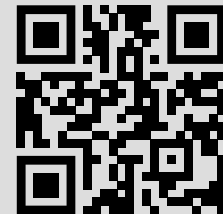

## Machine learning aided geospatial data acquisition

### Company

InterMap has 24 years of experience developing hardware and software solutions for collecting, managing and sharing geospatial data, employing most recent advances in the mapping and IT fields, assisting the job of surveyors, municipalities and infrastructure planners.

### Challenges & Solution

To acquire accurate and useful data with the least possible manual labour, efficient machine learning models must be trained. These training sessions require vast amount of computer resources.

By employing HPC resources, the training time can be significantly reduced, thus more experimental solutions can be examined. Furthermore, with more processing capability, more complex models can be trained, which opens up new data acquisition methods.



*Image processing results on ground survey images, from which spatial data can be generated.*

### Benefits

- Faster training of experimental models
- Scalable resource allocation to match model complexity
- Parallel processing results in more generic models

*“We were able to deploy our training pipeline to the Komondor HPC, provided by the KIFÜ and the results are the expected: more complex image processing models can be trained in much less time, which would not be possible on consumer-grade hardware.”*

**Gergő Tóth, Technology developer @InterMap**

### Full story:



## Large-scale protein structure prediction using ParaFold

### Company

Delta Bio 2000 Ltd. is a biotech company with expertise in cancer diagnostics, which integrates next-generation sequencing technology to detect new tumor markers and drug targets.

### Challenges & Solutions

Protein structures contain essential information that can be utilized to develop more effective pathogenicity prediction algorithms. Performing large-scale protein structure prediction on a standard computer is virtually impossible due to the extensive computational resources needed.

Exhaustive benchmarking was conducted to determine the computational resources required to predict proteins ranging from 50 to 5000 amino acids long. Komondor's infrastructure allowed Delta Bio to generate thousands of protein structures within weeks.



Superimposition of Proline dehydrogenase 1 structure generated by three publicly available algorithms.

### Benefits

- Rapid generation of wild-type and mutated protein structures.
- Significant reduction in protein structure prediction time on the GPU partition.
- Large-scale feature extraction process can be performed in minutes for thousands of proteins.

**“We aim to investigate the wealth of features extracted from mutated protein structures and develop novel approaches for improving missense variant prediction algorithms. Ultimately, this aids biologists and clinicians in characterizing cancer variants with greater accuracy, especially those of unknown significance”.**

**Lajos Haracska CEO @Delta Bio**

*Full story:*

## AI-POWERED DRUG DISCOVERY

### COMPANY

VRG Therapeutics is a leader in pharmaceutical R&D with a world-class AI-driven drug discovery platform. Our mission is to cure diseases by targeting therapeutic mechanisms beyond the reach of traditional approaches. By integrating computational and laboratory capabilities, our platform enables the development of miniprotein-based precision therapies with exceptional properties.

### CHALLENGES & SOLUTION

Autoimmune and chronic inflammatory diseases affect over 1 billion people worldwide, with a high unmet need for effective treatments. Current therapies pose safety risks due to general immunosuppression, increasing infection susceptibility and leaving many patients unresponsive. This underscores the urgent demand for more precise, targeted therapies—what we call precision therapies.

By combining the precisely engineered, computationally designable miniproteins with our state-of-the-art technologies, we develop next-generation drugs using AI-assisted tools.

"Leveraging high-performance computing on Komondor, provided by KIFÜ, accelerates and scales-up our computational protein design and evaluation. This allows us to develop impactful therapies and to successfully compete in the global biotech RnD market."

**Gábor Oroszlán PhD, In Silico Lead @VRG Therapeutics**

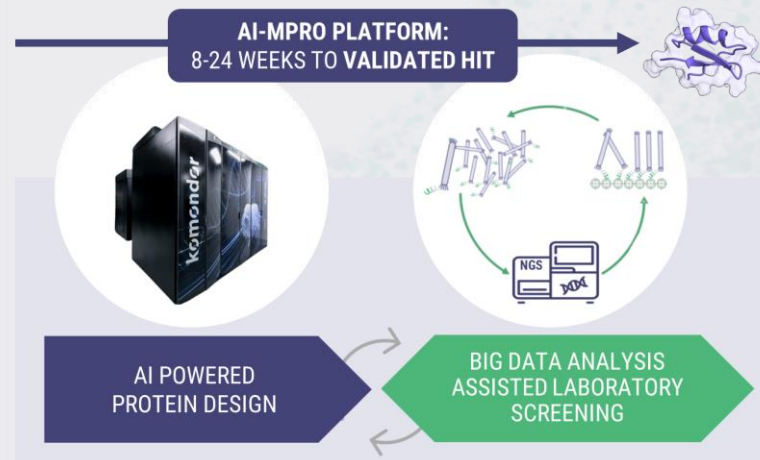

COMPUTATIONAL AND LABORATORY TECHNOLOGIES  
WORKING TOGETHER TO RAPIDLY DELIVER VALIDATED  
DRUG CANDIDATES IN JUST A FEW MONTHS

### Benefits

- ✓ Innovative miniprotein modality enabling efficient computational design
- ✓ AI-driven drug development reducing costs and improving quality
- ✓ Precision therapies with an excellent safety profile

**Full story:**



Latvia

## Topological optimization using HPC for medical devices

### Company

CastPrint is a Latvian SME that provides clinics with custom-made 3D printed casts for wrist, finger, leg fractures. The casts are lighter and more breathable than the traditional gypsum fixtures.

### Challenges & Solution

#### The Challenge

Creation of a 3D printed cast is a time-consuming and resource intensive process. Since the 3D scans used for production contain huge numbers of surface elements, processing the data on typical office computers is both slow and often unreliable, with software crashes resulting in data loss and delayed delivery to patients.

#### The Solution

Integrating parametric model optimization into the design process of the medical device. This involves using simulations to determine the most efficient shape for the cast, which in turn reduces the amount of material required and shortens printing times.

The use of HPC enables faster and more effective simulations, automating certain aspects of the design process and ultimately reducing the time spent on it.

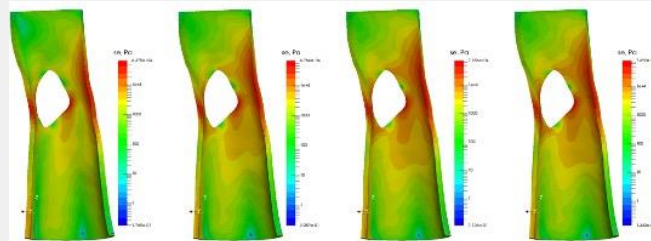

### Benefits

- 20% reduction in labor hours for cast design, which also reduces the risk of human error.
- Approximately 25% reduction in production material use through topological optimization.
- 25% reduction in production time through material optimization and shorter printing durations.
- Up to 15% reduction in production costs.
- Up to 25% enhanced production capacity at CastPrint.

*“There are many challenges in the production of fixators. The most important ones – how to shorten production time? how to reduce manual steps? how to save 3D printing times? These challenges also had a solution: parametric model optimization and HPC technology.”*

**Janis Olins, CEO @CastPrint**

### Full story:





## AI algorithm for molecule recognition

### Company

Semantic Intelligence has developed an AI-driven IP Intelligence Engine enables scientists & IP experts to search, analyze and extract complex knowledge on chemical-biological interactions

### Challenges & Solution

#### Challenge

How to index molecular images quickly & efficiently to provide users with the fastest possible access to current, published patents? The data base is one of the largest patent databases: USPTO (United States Patent and Trademark Office) with 5 million patent documents, more than 50 million molecules.

#### Solution

AI algorithm training in molecule recognition & integration into existing data processing workflow.

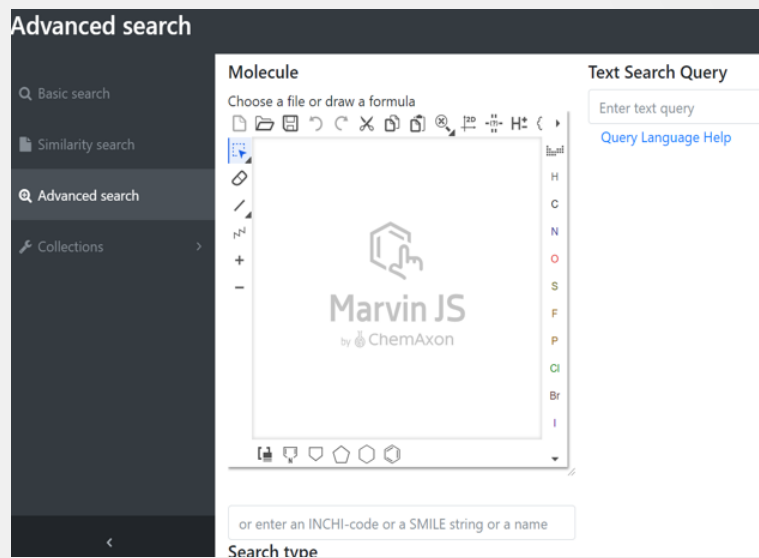

### Benefits

- Successfully completed algorithm training on the database
- Confidence in the effectiveness of the HPC center infrastructure and process
- Expected time & cost saving benefits (~20-30%)

*“Use of HPC allows us to perform a completely new approach to rapid analysis of big data in biopharmaceuticals, combining both structured and unstructured data to provide a data-driven, critical decision-making process to our clients.”*

**Vita Sture, CEO @Semantic Intelligence**

### Full story:





## Classifying emotions from tone of voice for call-centres

### Company

Asya.ai is producing pitchpatterns.com which is the best call-centre analytics and automation software

### Challenges & Solution

Emotion classification from tone of voice is complicated, because lack of public datasets and lack of open-source models. It is also necessary to have significant hardware resources to do hyper-parameter search in order to train your own model.

With collaboration with RTU HPC we managed to train our own emotion classification model to detect Happiness, Anger, Sadness and Neutral emotions in tone of voice. It achieved 95% accuracy.

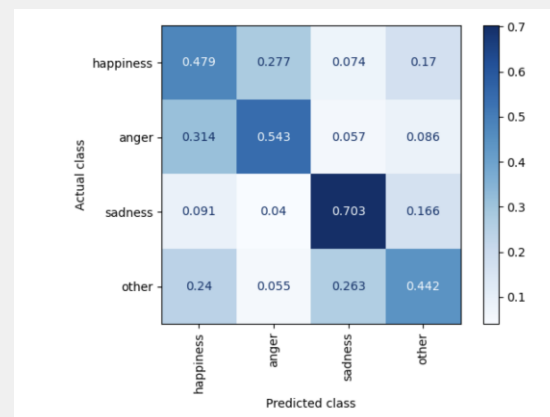

Emotion classification from tone of voice before HPC project: 52% accuracy

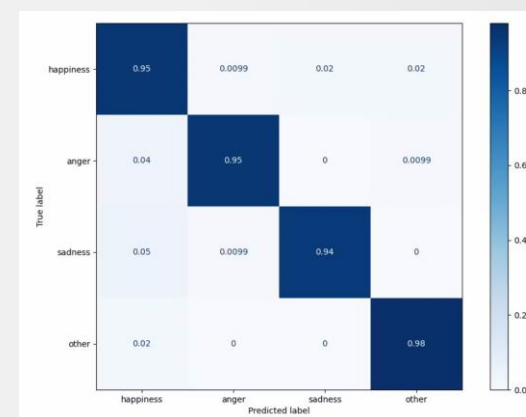

Emotion classification from tone of voice after HPC project: 95% accuracy

### Benefits

✓ Training Deep Learning models

🔑 New feature and unique selling point for the product

*“Call-centres use tone of voice emotion classification to improve quality of the service. This feature is unique selling point for pitchpatterns.com software”* Evalds Urtans, CEO, asya.ai

### Full story:



## Skin lesion diagnostic device

### Company

Medical device company specialised in the research and development of skin cancer diagnosis products. More than 10 years in biophotonics research and device development.

### Challenges & Solution

Skin images, especially in multispectral range have a lot of valuable information to help detect malignant lesions at early stage. Deep learning AI methods can help but require a lot of resources to train.

HPC GPU resources allowed to fit high-resolution model in the memory, that would be impossible on typical high-end GPU.

Custom built diagnostic device

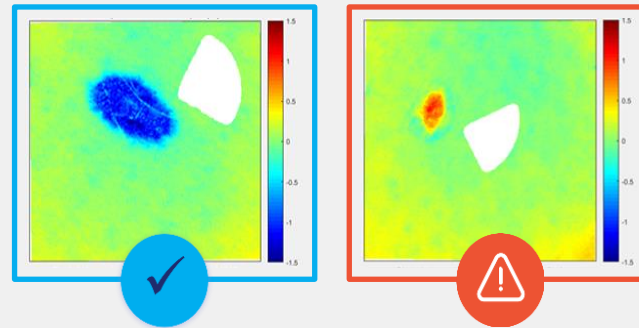

Benign (left) and malignant lesion (right) detection

### Benefits

- Cloud based AI model provides result in seconds
- Clinically validated on more than 4000 lesions
- Wireless and Ergonomic design for easy of usage
- Multispectral imaging analyzes skin at cellular level

*“At Bdetect, our goal is to democratize early skin cancer detection by providing intuitive, affordable, and accurate diagnostic tools that require no medical expertise. We are committed to saving lives through innovation, making advanced healthcare accessible to all”*

**Ronalds Skulme, CEO @Bdetect**

**Full story:**



Portugal

## Innovating Portugal's Footwear Industry

### Company

Atlanta, founded in 1995, excels in innovative sole production for the footwear industry. With advanced facilities, they craft 20,000 pairs daily, blending design, quality, and technical expertise.

### Challenges & Solution

Portugal's footwear industry faces challenges in optimizing sole design due to reliance on trial-and-error methods, which are time-consuming and resource-intensive. The introduction of computing in this process offered a solution by enabling simulation before physical testing, which optimized mold design and reduced iterations.

A collaboration between the University of Minho and Atlanta, within the GreenShoes 4.0 project, leveraged computational modeling to enhance product quality and streamline production, driving the sector's digital transformation.

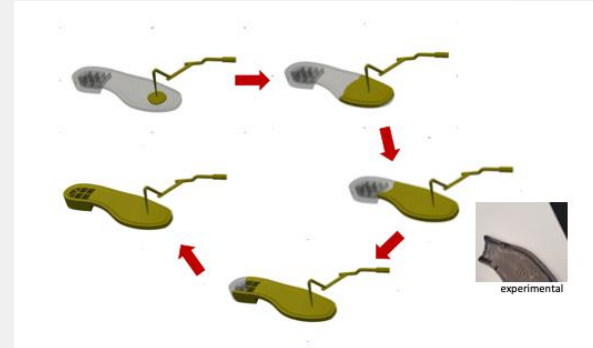

### Benefits

- Optimized mold design for better precision
- Reduced time and material costs
- Enhanced product quality by avoiding weak regions
- Improved process efficiency and faster production cycles
- Informed decision-making with detailed simulation data
- Support for innovation in manufacturing techniques
- Contribution to the digital transformation of the footwear industry

*“The (injection) machine had occupancy rates of 65% when we did manual planning. This planning took up dozens of hours a week and now, with these solutions, it takes us between 3 and 4 hours a week. It was an abysmal difference both for the planning team and for the occupancy rate of the machines. Now the occupancy rate has risen by around 20% to around 85%.”*

**André Santos, IT Director @ AMF**

### Full story:



## Extrusion Blow Molding Simulator

### • Company

Logoplaste, founded in 1976, pioneers in-house rigid plastic packaging, delivering innovative, eco-friendly solutions that reduce CO2 emissions and support a circular economy.

### • Challenges & Solution

The extrusion blow molding (EBM) process for creating hollow containers involves complex materials and multiple parameters that traditionally rely on trial-and-error methods, which are resource-intensive and time-consuming. To address these challenges, the University of Minho and Logoplaste Innovation Lab developed advanced numerical codes to simulate the entire EBM process. By porting these simulations to HPC systems and integrating optimization tools, they achieved more accurate, efficient, and scalable solutions, significantly reducing time-to-market.

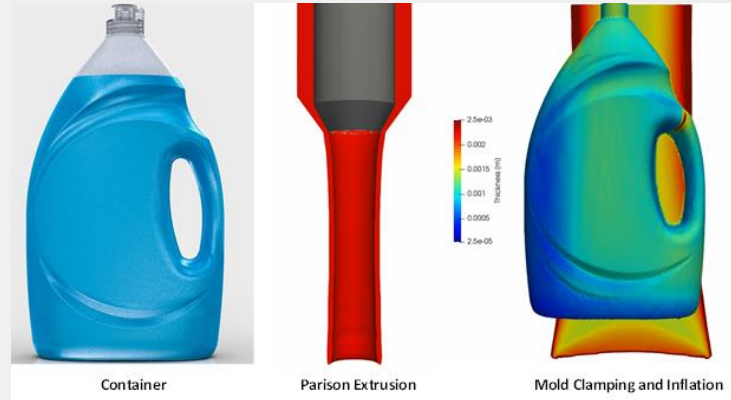

### Benefits

- Optimized process parameters, reducing trial-and-error
- Shorter time-to-market for products
- Enhanced accuracy in design and material predictions
- Increased resource and cost efficiency
- Scalable simulations using HPC
- Continuous improvement through ongoing tool development
- Data-driven decisions via optimization tools

### Full story:

*Computational modeling through HPC helps set optimal process parameters, reducing reliance on trial-and-error methods.*



## Developing Optimized Drugs Against COVID-19

### Company

BioSIM bridges theory and experiment using advanced computational tools for Enzymatic Catalysis and Drug Discovery, while Crowdfight fosters scientific collaborations by connecting experts.

### Challenges & Solution

The challenges included rapidly identifying effective drugs to combat COVID-19, understanding the virus's Spike protein interactions, and managing a vast number of potential molecules. Traditional methods would have been too slow and resource-intensive. The solution was leveraging computational resources to create detailed 3D models, screen 200,000 molecules, and rank them by potential efficacy. This approach enabled efficient identification and optimization of promising drug candidates, ensuring their effectiveness against evolving variants.

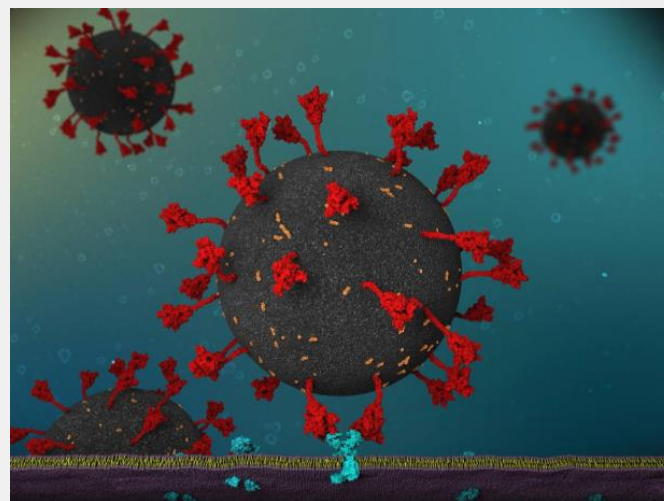

The interaction between SARS-CoV-2 Spike – Human ACE2

### Benefits

- Accelerated drug discovery
- Optimized molecule selection
- Enabled 3D modeling of virus-protein interactions
- Facilitated collaboration
- Ensured drug effectiveness against new variants

*“These computational resources allowed us to make a sort of ranking of molecules, from the least to the most promising. If we didn’t have access to them, we would have tested a much smaller number of these molecules and it would mean much less chance of success”.*

**Sérgio Sousa, Researcher @ BioSIM**

### Full story:



## HPC For Profile Extrusion

### Company

Soprefa is a Portuguese SME specialized in the production and distribution of plastic profiles for a large variety of applications. Wolf Dynamics is an Italian SME specialized in consulting services in computer-aided engineering, multi-physics simulations, numerical optimization, data analytics, and interactive data visualization.

### Challenges & Solution

Plastic profiles, crucial in sectors like healthcare and aeronautics, require precise design for specific applications. Traditional trial-and-error methods are time-consuming, costly, and heavily reliant on designer experience, particularly for complex geometries. This inefficiency hampers Soprefa's ability to develop new profiles and expand its business.

As a solution, Soprefa adopted computational tools using open-source libraries, integrating OpenFOAM and Dakota for HPC-based simulation and optimization. This streamlined the extrusion die design process, cutting down costs and time while improving product quality.

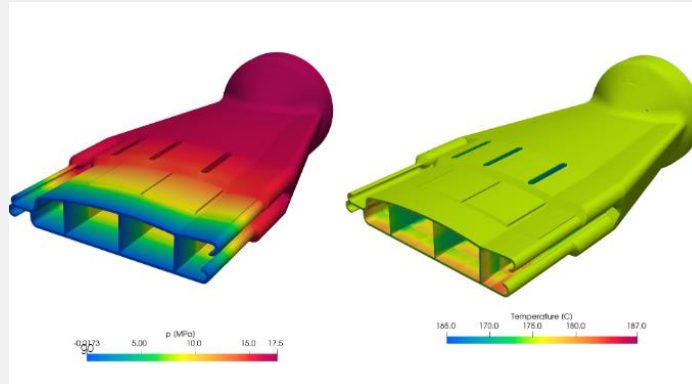

Profile extrusion is the technique employed to manufacture constant cross-section thermoplastic profiles, which has a vast range of major applications.

### Benefits

- Improved profile extrusion die design using simulation, optimization, and HPC systems.
- 30-40% faster product time to market (3 to 2 months).
- 40% reduction in raw materials (1 Ton to 600 kg).
- 23% cost reduction (€18,000 to €14,000 per tool).
- Greater independence in extrusion die design, protecting Soprefa's know-how.

*“The project teamed up with three entities with experience in this field to illustrate the benefits of HPC, especially when it comes to solving complex problems in the industrial sector, such as the design of profile extrusion dies.”*

**Miguel Nóbrega, Researcher @ University of Minho**

### Full story:



Slovakia

## Transfer and optimization of CFD calculations workflow in HPC environment

### Company

Shark Aero company designs and manufactures ultralight sport aircrafts with two-seat tandem cockpit. For design development they use popular open-source software package OpenFOAM.

### Challenges & Solution

- The CFD (Computational Fluid Dynamics) simulations use the Finite Elements Method (FEM). Model created in Computer-Aided Design (CAD) software is divided into discrete cells, so called "mesh". Computational requirements scale with the 3<sup>rd</sup> power of the mesh density
- Workflow consist of enclosing mesh creation, mesh segmentation, model inclusion and CFD simulation itself. Model inclusion (using snappyHexMesh program) is the time-limiting step.
- Efficient parallelization (using Message Passing Interface) requires thorough design of the mesh division into domains, in order to minimized data transfer necessary for resolving boundary conditions.

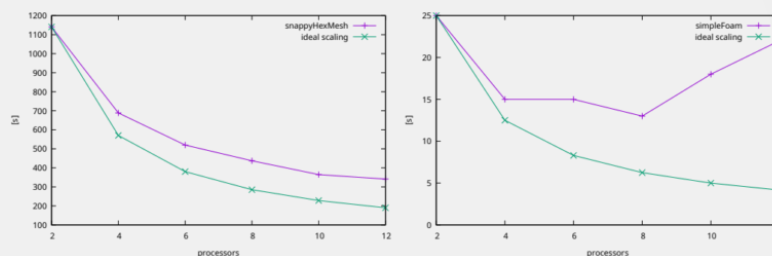
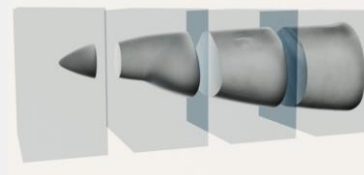

From reality to model (top); parallel scaling of selected workflow steps (bottom)

### Benefits

- ✓ 8x speed-up was achieved by migration to HPC. Aircraft parts design requires simulations of a relatively small models, but numerous times during the optimization.
- ✓ Higher speed-up is expected with increasing the problem size.

“Thanks to HPC we were not only able to run multiple simulations simultaneously, but we could also use much more refined mesh, which was not possible before due to memory limitations of our local computers.”

**Petr Sterba, Chief Engineer@SHARK.AERO, Ltd.**

### Full story:



## Anomaly Detection in Time Series: Gambling prevention using Deep Learning

### Company

DOXXbet, Ltd. – betting and online casino; Codium, Ltd. – software developer of betting and iGaming platform, focused on enhancing customer service and players' engagement via identification and prevention of gambling behavior.

### Challenges & Solution

- Unsupervised Transformer-based autoencoder (AE) model was used to detect anomalies in the dataset generated by online casino players.
- Data consists of time series of 19 derived features reflecting players' behavior, such as net loss / gain, cash deposits / withdrawals in a sliding time window, login frequency, etc.
- Alignment of AE's reconstruction error and the so called proxy indicators (selected manufactured descriptors, such as "chasing loss") enabled us to distinguish between data anomalies and potential problem gambling of players, thus decreasing the false positive rate.
- Training model with more than 100k trainable parameters and gigabytes of data greatly benefited from utilizing GPU-accelerated HPC facility.

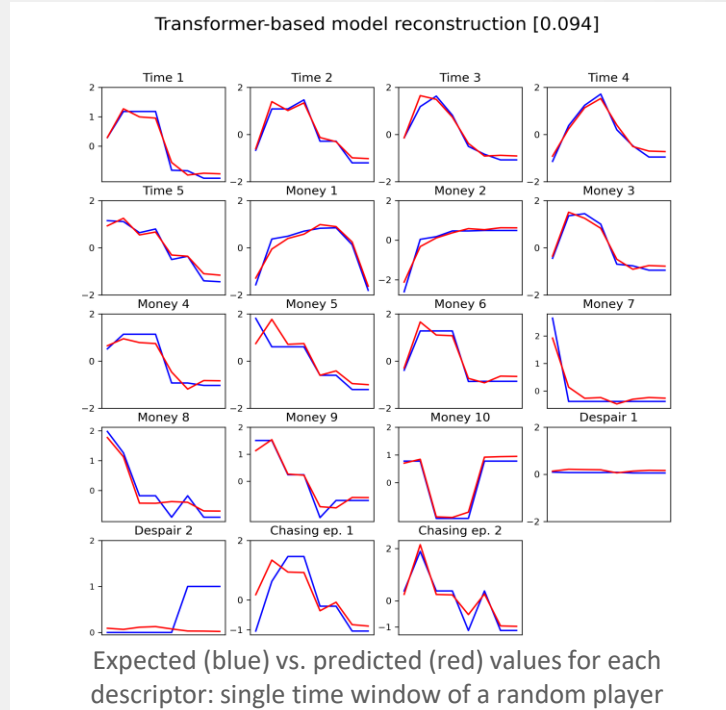

### Benefits

- ✓ Help betting and online casino providers mitigate negative consequences for players, which is in line with European trends in risk management.
- ✓ Real-time problem gambling detection using AI and Big Data thanks to HPC.

*"The accelerated module of the HPC system Devana allowed us to test several approaches to prevention of pathological online gambling. Powerful GPU accelerators were of great value in training and fine-tuning of sophisticated AI models."*

**Martin Varmus, CEO@Codium, Ltd.**

**Full story:**



## Semi-Supervised Learning for Building Extraction in Aerial Imagery

### Company

**Geodeticca Vision, Ltd.** is complex solution provider in collecting, processing, and application of geospatial data for engineering, and industrial geodesy and land registry.

### Challenges & Solution

- **Goal:** Growing need for automated building extraction is pivotal for urban planning in environmental studies, infrastructure management, detection of illegal constructions, etc. GIS applications often require *vector polygons*. Existent *Frame Field learning* (FFL) methods are based on *supervised learning*, thus require large amount of labeled data.
- **Solution:** identification, implementation, and evaluation of *semi-supervised approach* for FFL with significantly reduced reliance on labeled data.
- PyTorch Lightning's Distributed Data Parallel Strategy allowed for close to linear scaling on multi-node / multi-GPU HPC architecture.

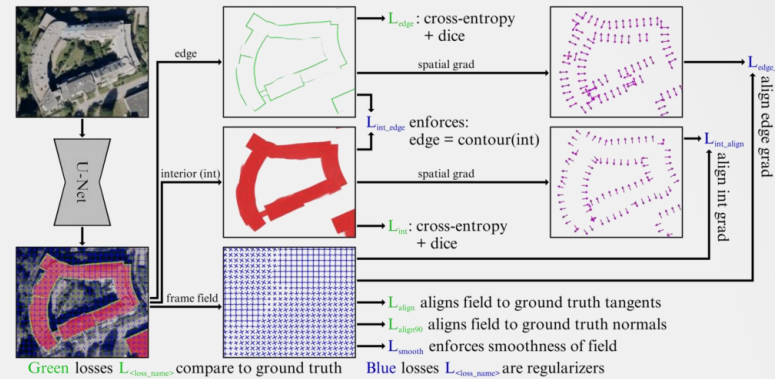
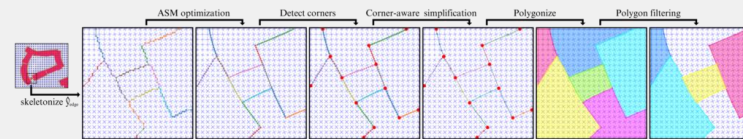

Diagram of the Frame Field Learning method.



Visualization of the vectorization process.

### Benefits

- Employing semi-supervised learning significantly enhances the model's performance across several key metrics
- Efficient parallelization and utilization of HPC resources notably decreases processing time

*"HPC helped us to achieve significant improvements in the accuracy of our algorithms in a short period. This collaboration has opened up new possibilities for further research and development in the field of geospatial data, ultimately contributing to the expansion of our services and increased satisfaction of our clients."*

**Marek Kožarík, CEO@Geodeticca Vision**

**Full story:**



## Mapping Tree Positions and Heights from LiDAR PointCloud Data

### Company

**Skymove, ltd.** - specialists in aerial work with UAVs, spatial data, geographic information systems and geodesy

### Challenges & Solution

**Goal:** Set up workflow for efficient tree location and height determination from data obtained using LiDAR (Light Detection and Ranging) technology mounted on drones.

**Result:** LiDAR PointCloud processing on HPC was implemented using R language with lidR library (filtering, classification, segmentation, and object extraction). Tree trunks are located using the DBSCAN clustering algorithm in custom Python program. Tiling of input PointCloud allows for (close to) ideal parallel scaling, thus enabling efficient processing of large data volumes (i.e. extensive area) using HPC.

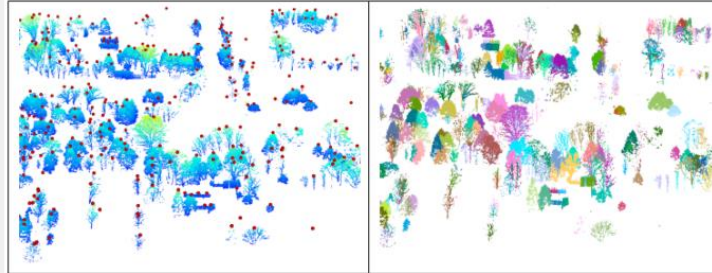

Tree positions (left) and corresponding tree segments (right) identified using the lidR library.

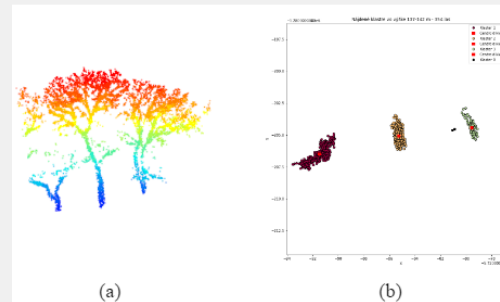

Clustering of segments of a PointCloud.

### Benefits

- Although locating trees can be a challenging problem (particularly in dense vegetation, or in presence of misclassified artefacts), its automation is of high interest
- HPC is indispensable for processing large volumes of high-quality LiDAR data

*“Thanks to the exceptional capabilities of the new supercomputer, we were able to identify processes that will lead to more efficient work and better results in the coming years. We also see great potential in tasks related to artificial intelligence.”*

**Robert Straka, CPO@Skymove, ltd.**

**Full story:**



## Intent Classification for Bank Chatbots through LLM Fine-Tuning

### Company

**Nettle, Ltd.** builds AI driven conversational platforms that use Natural Language Processing (NLP) and Artificial Intelligence (AI) to analyze, understand and derive meaning from unstructured text.

### Challenges & Solution

**Goal:** “Structured approach” to chatbot interaction (i.e. content of responses is predetermined) is sometimes preferred to ensure accuracy of information and adherence to the business’s branding. Pivotal challenge is thus to accurately identify user’s intent based on their (textual) input, in Slovak language.

**Solution:** Fine-tuning of *SlovakBERT*, *banking-tailored BERT*, and generative models *Gemma 7b instruct* and *Llama3 8b instruct*, and evaluation of their performance.

Utilized HPC resources enabled handling of the extensive computations required for fine-tuning LLMs

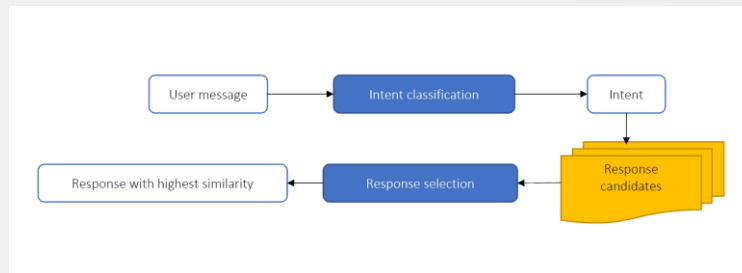

Diagram of the workflow.

Model Name	In-scope Accuracy	Out-of-scope FPR
Baseline proprietary model	67.6	22.5
SlovakBERT fine-tuned	77.2	6.3
Banking-tailored BERT	68.5	4.0
Gemma 7b instruct pre-trained	69.5	73.6
Gemma 7b instruct fine-tuned	70.6	4.6
Llama3 8b instruct pre-trained	65.5	14.1
Llama3 8b instruct fine-tuned	75.1	7.0
gpt-3.5-turbo pre-trained	76.6	32.4
gpt-3.5-turbo fine-tuned	79.5	4.3

Accuracy of the foundation and fine-tuned models.

### Benefits

- Experiments with data sets, prompt engineering and fine-tuning setup yield final accuracy of 77% (10% improvement) using open-source LLM SlovakBERT
- Extensive training on HPC resulted in a model deployable on commodity GPU

*“We used the Devana supercomputer for training language models that assist us in extracting key entities from text. This helps us create chatbot and voicebot applications with a new level of user experience.”*

**Andrej Greguš, co-founder of Nettle, Ltd.**

**Full story:**



## AI for Early Breast Cancer Detection

### Company

The University of Žilina is a Slovak Research Institution specializing in AI, data analytics and medical imaging, focusing on AI-driven innovation in healthcare.

### Challenges & Solution

Mammography screening generates massive volumes of high-resolution image data. The project processed over 434,000 mammograms and used a foundation AI model with nearly one billion parameters, exceeding standard research infrastructure capabilities. Access to the VEGA AI Factory in Slovenia, part of EuroHPC, provided NVIDIA H100 GPUs, enabling large-scale data processing, efficient model adaptation and iterative training focused on detecting subtle mammographic patterns.



### Benefits

- Enhanced support for radiologists in breast cancer screening
- Lower risk of missing subtle or early stage abnormalities
- Faster, more reliable and consistent mammography assessments

### Full story:

*“Our ambition was not to replace doctors, but to help them see more, faster and with greater confidence. By combining medical expertise, artificial intelligence and EuroHPC supercomputing, we aim to support earlier detection of breast cancer and reduce uncertainty in screening decisions.”* **prof. Dr. Mgr. Ivan Cimrák, University of Žilina**



Spain

# Use of AI for satellite-based surface wind correction

## Company

Nologin Oceanic Weather Systems (NOW Systems) is an EC Copernicus Marine Service provider for the European Atlantic façade. Since 2018 they co-lead the IBI-MFC (Iberia-Biscay-Ireland Monitoring & Forecasting Centre) with Mercator Ocean International, delivering regional forecasts in collaboration with Meteo-France and CESGA.

## Challenges & Solution

The main objective of this experiment is the feasibility analysis of the use of Artificial Intelligence techniques for the improvement of resolution and correction of winds generated by regional atmospheric models using satellite SAR remote observation data, using the European Copernicus service.

A neural network has been developed and trained that is capable of generating a wind field at a higher resolution than the original model, including the patterns seen in the SAR and it can be generalized to any area of the planet.

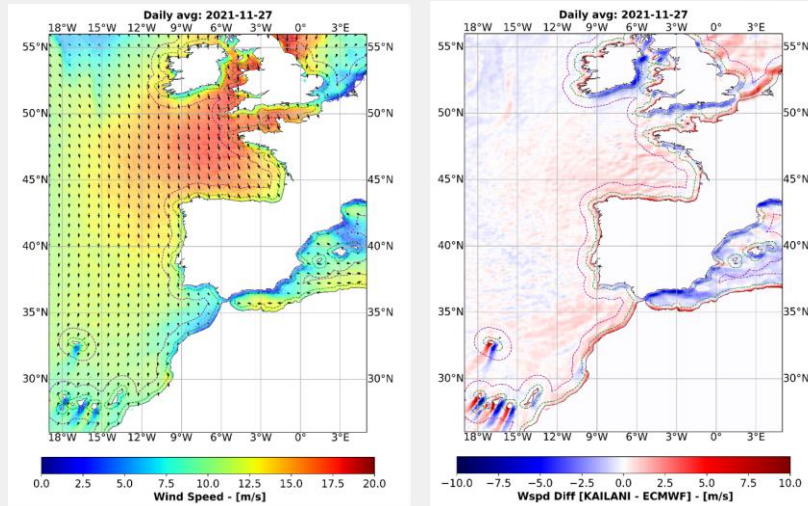

Performance of artificial intelligence in extreme events.

(left) Daily mean wind speed in the storm of 27 November 2021, preceded with Artificial Intelligence.

(right) Differences between Artificial Intelligence prediction and ECMWF dynamic model.

## Benefits

- High availability of nodes allows to optimize the time spent on neural network development, ensuring that several experiments can be queued.
- Faster training thanks to GPU-enabled nodes, which allows optimizing the architecture and obtaining more accurate results that improve coastal circulation and wave models.
- The use of HPC in all phases of the process reduces execution times and therefore optimizes R&D development costs.

## Full story:

*“Significant time reduction by an order of magnitude. The capacity of the GPU nodes allows training of large batches, minimizing errors during AI training. The processing speed of the GPU considerably reduces the training time of the different tests until the optimal architecture is found.”*

**Jose Maria Garcia-Valdecasas, Coastal Services Manager @NOW Systems**



**EuroCC**  
**SPAIN**





## Prediction of molecular structures based on fragmentation spectra

### Company

Kimatec (Maavi Innovation Center) is a biotechnology company focused on the agroalimentary world that offers radically innovative natural alternatives and solutions of equal efficacy to those obtained through chemical synthesis, thus achieving a balance between productivity, sustainability and health preservation.

### Challenges & Solution

The main motivation of this proof of concept was to develop and compare different Deep Learning models that allow to predict, in silico, the fragmentation profiles of all-natural compound known so far to increase the identification by high resolution mass spectrometry.

Several models were used to predict the different fragmentation profiles. This allowed us to compare the performance of each of these predictive models to be used in the future for the augmentation of natural compound identification databases.



### Benefits

- By increasing the number of molecules identified, we can increase the identification of bioactive compounds, i.e., attribute an activity to a natural compound.
- It allows us to know new mechanisms of action or new uses for previously described natural bioactive compounds.

### Full story:

*“Increase of the molecule identification database by means of fragmentation profiles predicted in silico. It is estimated that this will increase the identification of molecules in a chromatogram from the current 2% to 31%”*

**Álvaro Polonio Escalona, Director of Molecular and Computational Biology @Kimatec**



Sweden

## Sweden's Meteorology & Hydrology Institute digitizes archival tabular data using LUMI

### Company

The Swedish Meteorological and Hydrological Institute (SMHI) is an expert authority with a global perspective and a vital task of predicting changes in weather, water and climate.

### Challenges & Solution

SMHI, possesses troves of archival data of observations spanning decades in paper format. The ambition of the project is to optimize and train a sufficiently accurate machine learning model which can handle different forms of tabular data, convert handwritten-text and produce machine-readable. SMHI aims to use a combination of image processing and machine learning to achieve this. The digitization pipeline is implemented in Python, using well-known open-source scientific libraries such as scikit-image and TensorFlow.

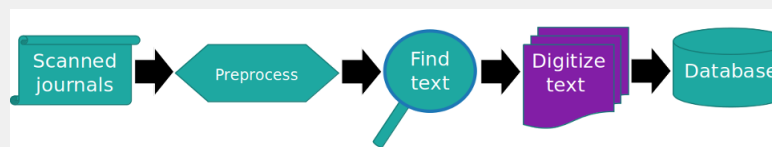
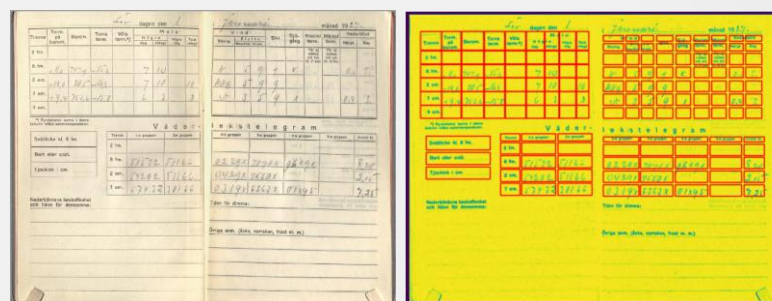

### Benefits

This project aids and accelerates the digitization work from the paper archives into data, which is done manually as of now. As a result of the project, SMHI aims at digitizing numerous historical weather observations that will help a better understanding of climate, especially of the occurrence of extreme weather events.

*“A HPC allocation enables us to rapidly test and develop the product. (...) GPUs allow faster tuning hyperparameters of this model. On CPUs the neural network training takes 11 hours. On GPUs the whole training takes only 1 hour.”*

**Ashwin Mohanan, Scientific programmer at SMHI**

**Full story:**



## SLB-analys Analyse Air Pollution Flow Using MeluXina Supercomputer

### Company

Stockholms luft- och bulleranalys (SLB-analys) is a unit at the Environment and Health Administration of the City of Stockholm. The unit is responsible for monitoring outdoor air quality in the city.

### Challenges & Solution

The dispersion of aerosol particles in urban environments heavily depends on meteorological parameters, in particular air flows. SLB-analysis run scaling tests on EuroHPC JU resources to push the boundaries of CFD simulations using OpenFOAM to larger spatial domains and higher complexity.

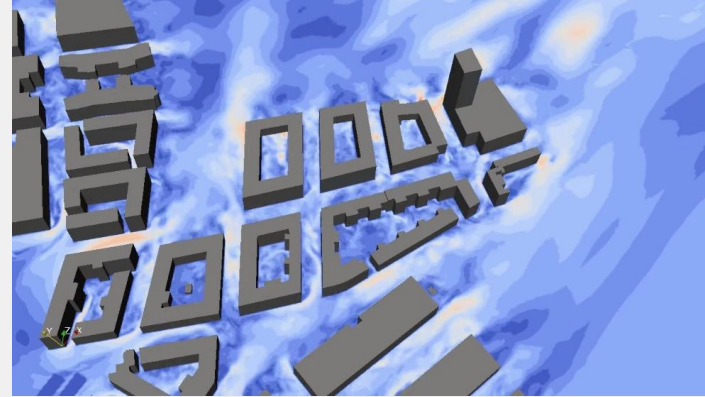

### Benefits

- Simulating larger urban area becomes possible
- Time-to-solution is greatly reduced
- Better results used for air quality assessment

*“By using more complex turbulence models, the accuracy of the results will be improved so that there can be an investigation whether new developments will meet air quality limits and propose measures to improve air quality in sensitive areas.”*

**Qiang Li, Research software engineer, ENCCS**

**Full story:**



## Nilar automates battery inspection using AI vision on Vega

### Company

Nilar AB develops and manufactures batteries that are safe and re-usable, which is crucial for a climate transition that works, i.e. that electricity is actually there when it is needed and not just when it is generated.

### Challenges & Solution

Quality inspection is an essential part of the battery manufacturing process, since quality determines battery performance, lifespan, and safety. Inspection should ideally be done for every part of every battery, but the high production rate makes this very difficult to achieve without automation. ENCCS and Nilar AB have leveraged the computational resources that the EuroHPC JU Vega cluster provides and the large image datasets Nilar has collected from their assembly lines to develop an AI-based computer vision solution as a first step towards complete automation of Nilar's quality inspection process.

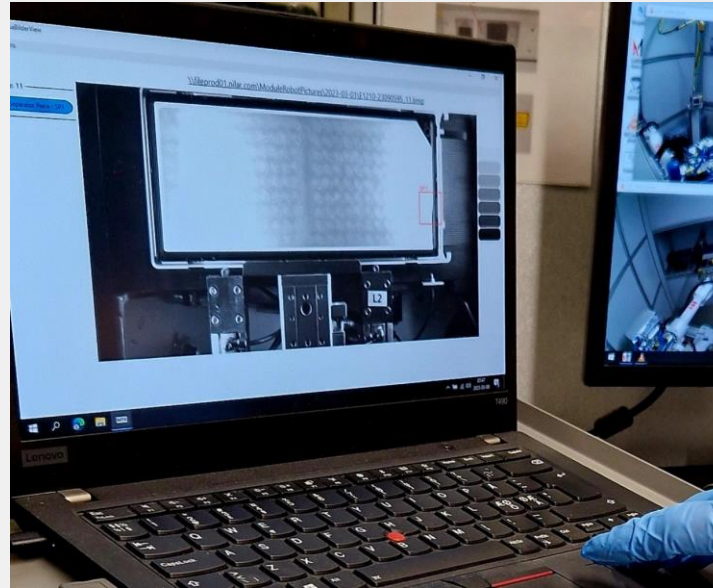

### Benefits

- Spot negative trends earlier
- Faster manufacturing adjustment
- Reduce scrap rate

*“From the supercomputing access, Nilar is already seeing benefits from the solution, such as being able to spot negative trends in quality earlier, which enables faster adjustment of process parameters to reverse these trends. This has helped reduce scrap rate, which in turn has led to a positive impact on their business.”*

**Andreas Thore, Researcher at ENCCS/RISE**

### Full story:



Türkiye

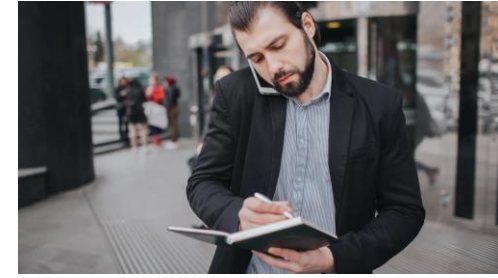

## Large Scale Real-Time Image Content Moderation

### Company

Founded in 2010, Machinetutors provides machine learning consultancy and customized AI software development services. Machinetutors empowers businesses all over the world by solving real-world problems.

### Challenges & Solution

This project addresses the problem of large-scale real-time image-based content moderation. The system is deployed to a production environment where tens of thousands of users browse the internet daily. The system must be both accurate and run in real-time to meet the business requirements. Moreover, the model size must be small so that multiple copies of the model can be run simultaneously on a GPU to reduce server costs. A major challenge has been making several models work efficiently together.

In order to solve the problem defined, we develop three main models. In the first model, we propose a multi-label NSFW classifier that can detect the NSFW levels (light, medium, hard) and predict other labels, such as the real person and clothing characteristics. The second model is a one-stage body-based age & gender detection model. Current age & gender methods are both face based i.e. they use face bounding boxes and are two-stage processes, they first run a face detector and then run the model on these boxes. When multiple faces are present in an image, this approach fails to meet the real-time requirement. The third one is a segmentation model. These three models run in a pipeline via which we can run various scenarios.

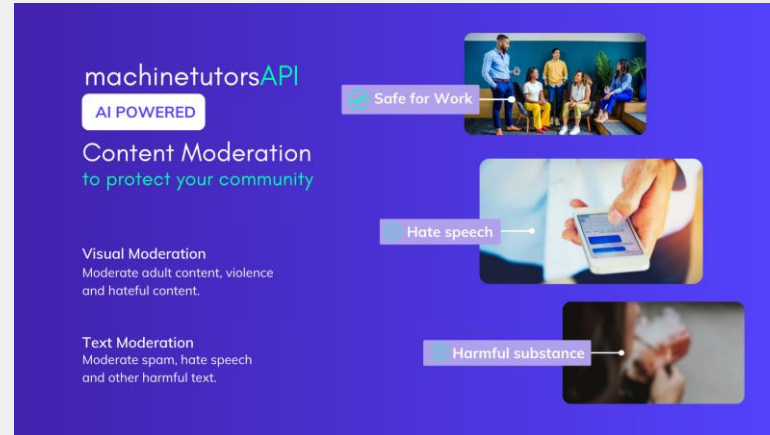

### Benefits

- ✓ Run many experiments in parallel
- ✓ Run larger batch size trainings on newer GPUs
- ✓ Access many GPUs for hyperparameter tuning
- ✓ Gain a considerable competitive advantage in the global AI ecosystem considering the speed and the cost-efficiency

*“EuroCC project made it possible for our company to play a major role in the transformation of a content safety technology start-up into a leading organization in Europe. The state of the art artificial intelligence models our team trained would not have been achievable without the computation resources they provided.”* **Eray Berger, CEO @Machinetutors**

### Full story:



## The multiphysics experiments of the Weather Research and Forecasting Model (WRF) on precipitation patterns of Turkey

### Company

ErikTronik Engineering is a corporation that operates in several domains including aviation, energy, meteorology, and defence. They offer solutions in aviation and navigation for both military and civilian airports, design algorithms and provide energy forecasts, transform data into decision-making tools in meteorology-dependent areas, and supply spare parts to defence agencies with certifications. Additionally, ErikTronik supports projects in Turkey and the EMEA region offering consultancy, engineering, sales and after-sales services, while also addressing challenges like climate change, food, and business intelligence through engineering solutions.

### Challenges & Solution

WRF model may provide accurate representation of the atmosphere and the surface conditions. However, such WRF model requires major parametrizations (e.g., cloud, planetary boundary layer, other physics options) to be optimized. On the other hand, simulations of WRF model require high computational resources to accomplish such optimization studies.

The project's sensitivity tests were completed over the Turkey domain for 2020, with a 60-combination of model physics in 4-km resolution. The combination number, resolution, and simulation time are rather comprehensive for such sensitivity tests. We have valuable information now about which multiphysics ensemble responds favorably to the Turkey precipitation characteristics.

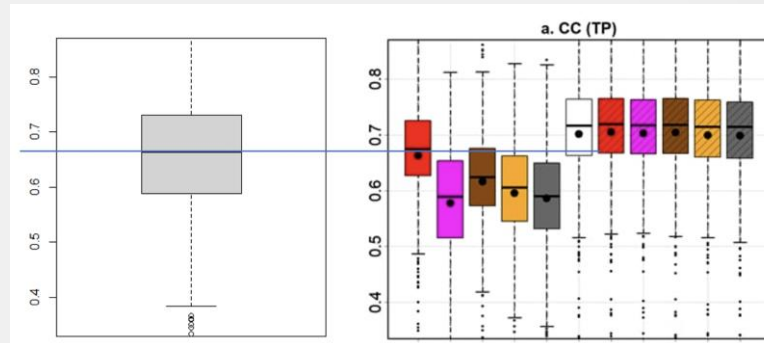

Previously available model performances (solid gray box on the right with a median 0.58) are improved to the level of European state of the art model accuracy levels (left gray box with median 0.66). These are very encouraging results compared with existing state of the art models.

### Benefits

- ✓ Gained experience for the first time in the HPC domain.
- ✓ Encouraged to apply to the EuroHPC projects in the seasonal forecast and climate prediction areas through gained experience with this project.
- ✓ Improved their insight into driving mechanisms of precipitation over Turkey.

*“ErikTronik's enhanced forecasting in Türkiye benefits climate-dependent domains by improving resource prediction, hydrometeorological forecasting, and climate change mitigation. This capacity aids in better water management and response to climatic adversities, supporting particularly the renewable energy and agriculture sectors in risk and operational handling.” Erdem Erikçi, CTO @Eriktronik*

### Full story:



## Fine-tuning speech-to-text models on HPC clusters

### Company

Erste Software (2017), located in Türkiye, is an SME focused on IoT, mobile device management, and using ML/AI techniques in practice.

### Challenges & Solution

The sales/quotation preparation process in manufacturing is a tedious task with back-and-forth messages in between the customer and manufacturer, since production requires high-precision under strict time-to-deliver constraints. A major part of the process is daily meetings between the engineering and sales teams. Recording this crucial know-how, transcribe it to enable semantic search for the current and future quotations is important. To address this problem, Erste's decision was to fine-tune a pre-trained model, Whisper, for Turkish. Yet an accurate fine-tuning requires significant computational power. Although Erste had experience in traditional ML training, they lack access and expertise on using multiple GPUs for this purpose. In this use-case, they leverage the expertise in the NCC Türkiye and computational resources to fine-tune a large-scale model.

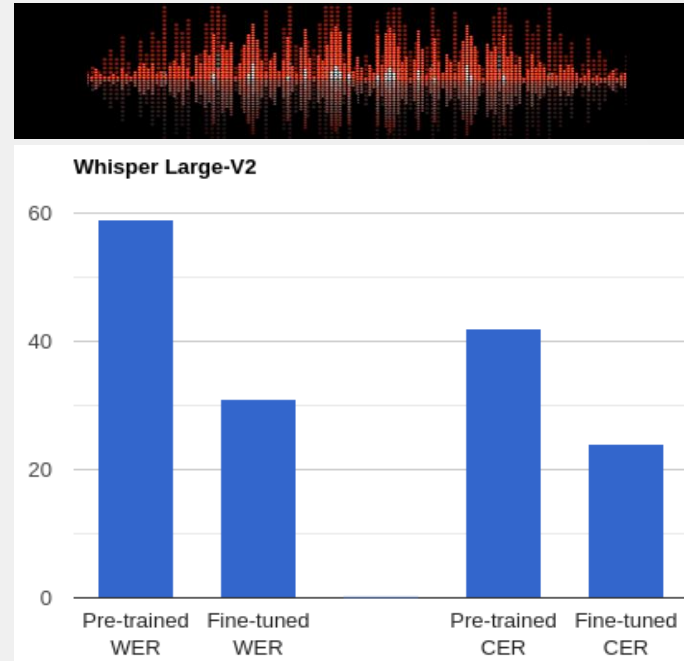

### Benefits

- ✓ Gained experience in utilizing TRUBA HPC resources and training large-scale models with large-scale datasets.
- ✓ Enhance the efficiency and quality of customer's manufacturing endeavours in the long run.
- ✓ Significantly improved the accuracy of Whisper, a speech-to-text model for Turkish.

*"Thanks to this opportunity, Erste Software had a rewarding experience on working with academicians and HPC experts in the EuroCC team. In addition to increasing the accuracy and cost-efficiency of our solution, for our future projects, we gained valuable experience on using HPC resources and working with large-scale datasets and models." Özer Aydemir, Co-founder and CEO @Erste*

### Full story:



## AI-Driven Style Transfer for Virtual Environments

### Company

Founded in 2014, VL Media is a software company focussed on designing and creating user-friendly social apps and games.

### Challenges & Solution

One of the projects carried out by the company is to customize the scene in the virtual environment and the audio-visual objects within the scene by the content producers. In order to make more original designs, different studies, and experiments will be carried out using the style transfer of these images determined by the content producer by using artificial intelligence. Style transfer is frequently used today thanks to the advancement of GPU technology. Since all the methods used by the company to realize such designs require GPU processing power.

The customized multi-GPU strategy adopted in the project is favoured for its alignment with the model's characteristics and workload requirements. DataParallel serves the purpose of providing more general and straightforward multi-GPU support, combining multi-GPU processing and multi-scale production to achieve high-quality, high-resolution results.

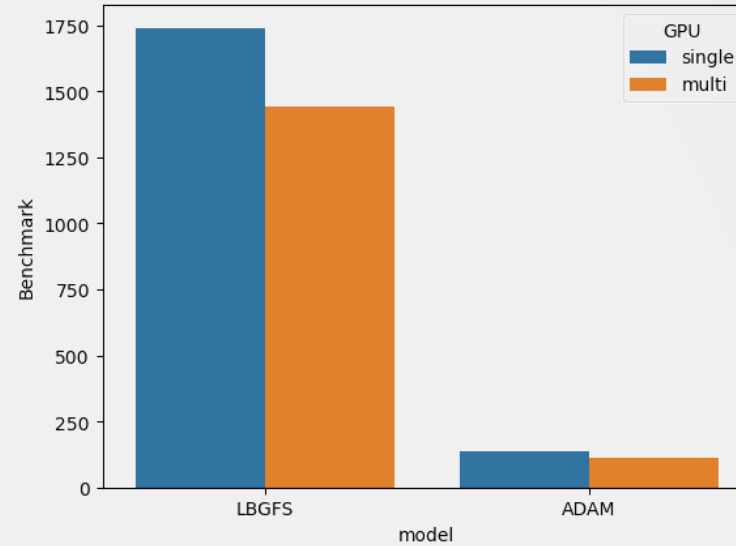

Benchmark Results

### Benefits

- ✓ Enhanced Customization in Virtual Environments
- ✓ Hybrid Style Transfer Technique
- ✓ Balanced Content and Style Preservation
- ✓ Customized Multi-GPU Strategy

*"I'm thrilled to collaborate with TRUBA's experts in the realm of style transfer. Together, the fusion of our creative ideas and high-performance computing, in the exciting domain of style transfer, is crafting a new visual language that will redefine what's possible."*

**Eda Yüksel, CRO @VLMedia**

**Full story:**



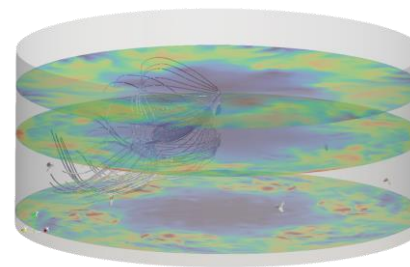

## Efficiency of Mechanical Mixers in Biogas Digesters

### Company

EYS Endüstri Makina is a company focused on practical solutions to organics recycling problems by putting to use their knowledge and experience in manure management, dewatering, and composting solutions. The company offers innovative and quality products to shape the future of the environmental and agricultural sectors.

### Challenges & Solution

Mixers or agitators are essential components of biogas digesters that are responsible for ensuring a homogenous mixture of organic material and maintaining optimal conditions for the growth of microorganisms that produce biogas. In terms of energy efficiency, the power consumption of mixers or agitators depends on several factors, such as the type of mixer, the size of the digester, and the characteristics of the feedstock. In this PoC, the company wanted to conduct unsteady, high fidelity CFD analyses of various biogas digesters (variable diameter and depth) with different mixer configurations (number of mixers and positioning). They are using open-source finite volume tools to assess the mixing performance and energy consumption of mechanical mixers.

The optimal number of processors for the open-source CFD solver OpenFOAM was determined by running benchmark cases. The production runs were conducted efficiently using the load-balancing data gathered from the aforementioned benchmark runs. A number of different mixer configurations were simulated. Then the results of these cases were postprocessed, and the dead zones inside the reactor, which inhibit biogas production, were investigated. Shorter run times were achieved thanks to parallelized runs with a number of cores up to 1024, compared to our local compute servers.

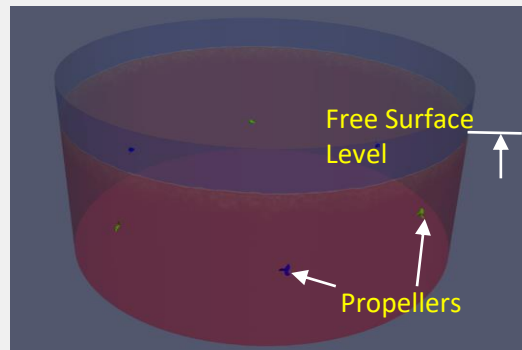

The full model of the digester

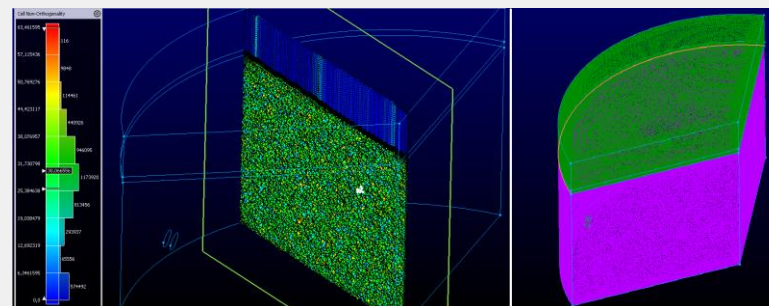

Mesh of periodic digester

### Benefits

- ✓ Closely monitor scalability and parallel performance metrics.
- ✓ Try to increase utilization of automated operations, such as on-the-fly data analysis, file transfer processes, or using certain software applications remotely on HPC servers, etc.
- ✓ Try to streamline steps in their flow chart, aiming to minimize human intervention in the process. (e.g., geometry generation, mesh generation, solver setup, etc.)

*"We have examined mixer positioning and mixing performance in high-capacity (i.e., volumetric capacities at the order of 10.000 m<sup>3</sup>) biogas digesters. We needed high-performance computing resources due to the large size of the digesters and time-resolved simulations with LES approach (i.e., the total number of computational cells  $O(10^7)$ ). At that point, the computational resources provided by the EuroCC program, were a big help for us in shortening the time needed for our iterative design process. Due to the time constraints and competitiveness of industrial scale engineering projects, we believe that the need for remote HPC systems will be a constant requirement for companies like us."* **E. Orçun Kozaka, R&D Manager @EYS Endüstri Makina**

### Full story:



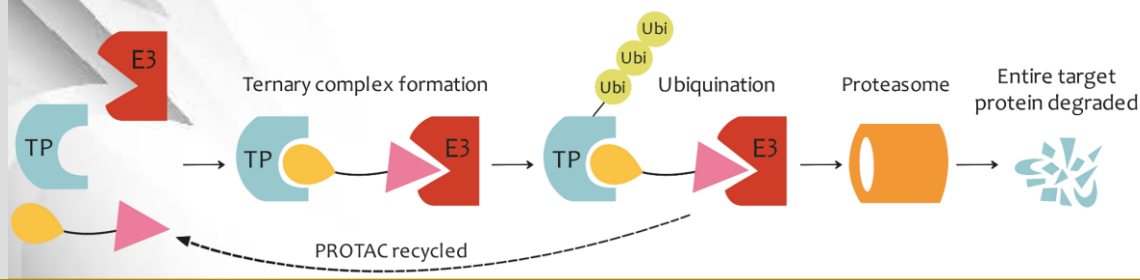

## Designing PROTACS for HIV-TAT using deep learning and molecular modeling methods

### Company

PeptiSyn is a company focussed on the production of peptides, both on a large and small scale, which are widely used in biomedical, medical, chemical, cosmetic, and other related areas.

### Challenges & Solution

The company carry out a project aimed to develop PROTAC molecule for TAT which is a pivotal protein in the life cycle of the HIV virus and drastically enhances the efficiency of viral infection. The artificial intelligence library that will be used in this project is designed for small molecules. Yet, it has not been tested on TAT protein, which is an intrinsically disordered protein. Thus, this will be the first challenge to apply this methodology. Using the ROSETTA program to model three-dimensional complex structure of PROTACS will be a challenge as the company does not have experience in this program.

Using deep learning methods the company created 5000 possible linkers for PROTACS. These linker molecules were filtered by their efficiencies to be used as PROTACS using molecular modeling, MD simulations and free energy calculations. Optimal linkers for experiments were identified.

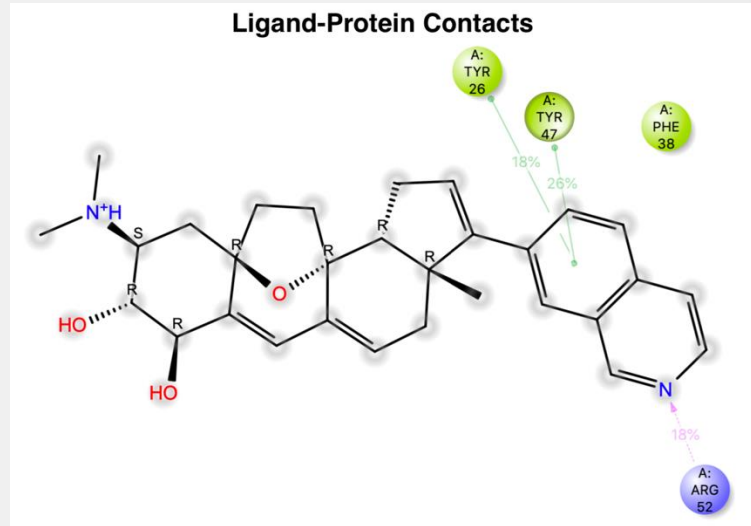

HIV-TAT dCA molecule interaction diagram

### Benefits

- ✓ Reducing effort and money spent on experiments
- ✓ Selecting more potent molecules
- ✓ Searching a large chemical space efficiently

*"I am thankful to be given the chance to carry out our calculations on TRUBA systems and the support given by the technical teams. Designing PROTACS is not an easy task, using AI and other molecular modelling approaches we could significantly saved time and reduced experimental costs"*

**Onur Alptürk, Director & co-Founder @PeptiSyn**

**Full story:**



# EuroCC: Use cases portfolio

coordinated by CASTIEL2-WP4



**EuroHPC**  
Joint Undertaking

This project has received funding from the European High-Performance Computing Joint Undertaking (JU) under grant agreement No 951732. The JU receives support from the European Union's Horizon 2020 research and innovation programme and Germany, Bulgaria, Austria, Croatia, Cyprus, Czech Republic, Denmark, Estonia, Finland, Greece, Hungary, Ireland, Italy, Lithuania, Latvia, Poland, Portugal, Romania, Slovenia, Spain, Sweden, United Kingdom, France, Netherlands, Belgium, Luxembourg, Slovakia, Norway, Switzerland, Turkey, Republic of North Macedonia, Iceland, Montenegro